



# Operating Manual

## Refrigerated Centrifuge



**8KS**

**8KBS**

from serial no. 143558

**Please retain for later use!**



---

In case of inquiries, please state the following numbers:

Order number:

Serial number:

© Copyright by  
Sigma Laborzentrifugen GmbH  
An der Unteren Söse 50  
37520 Osterode am Harz  
Germany

Tel: +49 (0) 5522 / 5007-0  
Fax: +49 (0) 5522 / 5007-12  
Web: [www.sigma-zentrifugen.de](http://www.sigma-zentrifugen.de)  
E-mail: [info@sigma-zentrifugen.de](mailto:info@sigma-zentrifugen.de)



<b>1</b>	<b>General information</b>	<b>9</b>
1.1	Importance of the operating manual	9
1.2	Intended use	9
1.3	Warranty and liability	9
1.4	Copyright	10
1.5	Standards and regulations	10
1.6	Scope of supply	10
<b>2</b>	<b>Layout and mode of operation</b>	<b>11</b>
2.1	Layout of the centrifuge	11
2.1.1	Functional and operating elements	11
2.1.2	Name plate	13
2.1.3	Mains plug	13
2.2	Mode of operation	14
2.2.1	Centrifugation principle	14
2.2.2	Area of application	14
2.2.2.1	Speed, radius, and relative centrifugal force	15
2.2.2.2	Density	15
<b>3</b>	<b>Safety</b>	<b>16</b>
3.1	Marking of the unit	16
3.2	Explanation of the symbols and notes	17
3.3	Responsibility of the operator	18
3.4	Operating personnel	18
3.5	Informal safety instructions	18
3.6	Safety instructions	19
3.6.1	Electrical safety	19
3.6.2	Mechanical safety	19
3.6.3	Fire prevention	20
3.6.4	Chemical and biological safety	20
3.6.5	Safety instructions for centrifugation	21
3.6.6	Resistance of plastics	21
3.6.7	Rotors and accessories	22
3.6.7.1	Lifting and carrying rotors	22
3.6.7.2	Service life	22
3.7	Safety devices	23
3.7.1	Lid lock device	23
3.7.2	Standstill monitoring system	23
3.7.3	System check	23
3.7.4	Earth conductor check	23
3.7.5	Imbalance monitoring system	23
3.7.6	Temperature monitoring system	23
3.7.7	Rotor monitoring system	23

## Table of contents

3.8	Measures in the event of hazards and accidents .....	24
3.9	Remaining hazards .....	24
<b>4</b>	<b>Storage and transport .....</b>	<b>25</b>
4.1	Dimensions and weight .....	25
4.2	Storage conditions .....	25
4.3	Notes on transport .....	25
4.4	Packaging .....	26
<b>5</b>	<b>Set-up and connection .....</b>	<b>27</b>
5.1	Installation site .....	27
5.2	Set-up and alignment of the centrifuge .....	27
5.2.1	Set-up .....	28
5.2.2	Alignment .....	28
5.3	Power supply .....	30
5.3.1	Connection .....	30
5.3.2	Fuses .....	30
5.3.3	Power isolating device .....	30
5.4	Condensate drain .....	30
5.5	Special equipment: water cooling system .....	32
<b>6</b>	<b>Using the centrifuge .....</b>	<b>33</b>
6.1	Initial start-up .....	33
6.2	Switching the centrifuge on .....	33
6.2.1	Opening and closing the lid .....	33
6.2.2	Installation of rotors and accessories .....	33
6.2.2.1	Installation of the rotor .....	34
6.2.2.2	Installation of angle rotors with a hermetically sealed lid .....	34
6.2.2.3	Installation of accessories .....	35
6.2.2.4	Adapters .....	36
6.2.2.5	Tubes .....	36
6.2.2.6	Blood bag systems .....	37
6.3	Control system "Spincontrol S" .....	38
6.3.1	User interface .....	38
6.3.2	Manual mode .....	39
6.3.2.1	Starting a centrifugation run .....	39
6.3.2.2	Interrupting a centrifugation run .....	39
6.3.2.3	Interrupting a deceleration process .....	39
6.3.2.4	Selection, display, and modification of data .....	39
6.3.2.5	Standard menu .....	40
6.3.2.6	Parameters menu .....	45
6.3.2.7	Setup menu .....	48
6.3.2.8	Curve menu .....	51
6.3.2.9	Help menu .....	52
6.3.2.10	Changing the contrast .....	53

6.3.3	Program mode.....	53
6.3.3.1	Loading a program.....	53
6.3.3.2	Saving a program.....	54
6.3.3.3	Deleting a program.....	55
6.3.3.4	Automatic program rotation.....	55
6.3.3.5	Options for data input and output.....	56
6.4	Switching the centrifuge off.....	56
<b>7</b>	<b>Malfunctions and error correction.....</b>	<b>57</b>
7.1	General malfunctions.....	57
7.1.1	Emergency lid release.....	58
7.2	Table of error codes.....	59
7.3	Service contact.....	60
<b>8</b>	<b>Maintenance and service.....</b>	<b>61</b>
8.1	Maintenance.....	61
8.1.1	Centrifuge.....	61
8.1.2	Condenser (only air-cooled centrifuges).....	62
8.1.3	Accessories.....	62
8.1.3.1	Plastic accessories.....	63
8.1.4	Rotors, buckets and carriers.....	63
8.1.5	Load bearing bolts.....	63
8.1.6	Glass breakage.....	64
8.2	Sterilisation and disinfection of the rotor chamber and accessories.....	64
8.2.1	Autoclaving.....	65
8.3	Service.....	66
8.4	Return of defective parts.....	67
<b>9</b>	<b>Disposal.....</b>	<b>68</b>
9.1	Disposal of the centrifuge.....	68
9.2	Disposal of the packaging.....	68
<b>10</b>	<b>Technical data.....</b>	<b>69</b>
10.1	Ambient conditions.....	70
10.2	Technical documentation.....	70
<b>11</b>	<b>Appendix.....</b>	<b>71</b>
11.1	Range of accessories.....	71
11.1.1	Maximum speed for tubes.....	73
11.1.2	Rotor radii.....	73
11.2	Speed-gravitational-field-diagram.....	74
11.3	Acceleration and deceleration curves.....	75
11.4	Table of the service life of rotors and accessories.....	77
11.5	Resistance data.....	78
11.6	EC-Declaration of Conformity.....	83
11.7	Layout plan.....	85
<b>12</b>	<b>Index.....</b>	<b>87</b>





# 1 General information

## 1.1 Importance of the operating manual

A fundamental requirement for the safe and trouble-free operation of the centrifuge is to be familiar with the fundamental safety instructions and all possible hazards.

The operating manual includes important information concerning the safe operation of the centrifuge.

This operating manual and, in particular, the notes on safety and hazards must be observed by all persons operating the centrifuge.

In addition, the local rules and regulations for the prevention of accidents must be complied with.

## 1.2 Intended use

Centrifuges are power-driven machines that separate liquids from solid matter, liquid mixtures, or solid mixtures by centrifugal force. They are solely intended for this purpose. Any other use beyond this area of application is regarded as improper use. Sigma Laborzentrifugen GmbH cannot be held liable for any damage resulting from such improper use.

The intended use also includes

- observation of all the notes and instructions included in the operating manual and
- compliance with the care, cleaning, and maintenance instructions.

## 1.3 Warranty and liability

The warranty and liability are subject to our "General Conditions" that were distributed to the operator upon the conclusion of the contract.

Warranty and liability claims are excluded if they are due to:

- improper use.
- non-compliance with the safety instructions and hazard warnings in the operating manual.
- improper installation, start-up, operation, or maintenance of the centrifuge.

## 1 General information

---

### 1.4 Copyright

The copyright concerning the operating manual remains with Sigma Laborzentrifugen GmbH.

The operating manual is solely intended for the operator and their personnel. It includes instructions and information that must not be

- duplicated,
- distributed, or
- communicated in any other way.

Non-compliance may be prosecuted under criminal law.

### 1.5 Standards and regulations

EC Declaration of Conformity  
(see chapter 11.6 - "EC-Declaration of Conformity")

### 1.6 Scope of supply

**The centrifuge comprises:**

- |   |                  |
|---|------------------|
| • 1 square spanner, size 8 (door)                           | Part no. 930 114 |
| • 1 open spanner, size 8/10<br>(adjustable feet front side) | Part no. 930 015 |
| • 1 open spanner, size 13/14<br>(adjustable feet rear side) | Part no. 930 013 |
| • 1 open spanner, size 24<br>(lock nuts heat adjustment)    | Part no. 930 024 |
| • 1 wrench, angulate, size 17/19 (rotor)                    | Part no. 26 448  |
| • 1 wrench, hex socket, size 4 (rotor)                      | Part no. 930 050 |
| • 1 tube wrench (emergency release)                         | Part no. 930 110 |
| • 1 hose connector for condensate drain (installed)         | Part no. 80 415  |
| • 1 tube of grease for load bearing bolts                   | Part no. 70 284  |
| • 1 bottle of slushing oil                                  | Part no. 70 104  |

#### **Documentation**

Operating manual incl. EC Declaration of Conformity

#### **Accessories**

according to your order, our order confirmation, and your delivery note.

## 2 Layout and mode of operation

### 2.1 Layout of the centrifuge

#### 2.1.1 Functional and operating elements

- 1 Lid
- 2 User interface (see chapter 6.3.1 - "User interface")
- 3 Mains power switch



Fig. 1: Total view of the centrifuge

- 4 Locks of the front door
- 5 Name plate (see chapter 2.1.2 - "Name plate")



Fig. 2: Right side of the centrifuge

## 2 Layout and mode of operation

- 6 Mains cable
- 7 Adjustable foot
- 8 Option: serial interface (see chapter 6.3.3.5 - "Options for data input and output")
- 9 Castor



Fig. 3: Rear view of an air cooled centrifuge

- 10 Cooling water connection (see chapter 5.5 - "Special equipment: water cooling system")



Fig. 4: Rear view of a water cooled centrifuge<sup>1</sup>

<sup>1</sup> Not for Sigma 8KB

### 2.1.2 Name plate

- 1 Manufacturer and registered office
- 2 Type
- 3 Serial number
- 4 Max. speed
- 5 Max. kinetic energy
- 6 Max. density
- 7 Nominal voltage
- 8 Input fuse
- 9 Symbol for special disposal (see chapter 9 - "Disposal")
- 10 CE mark in compliance with the directive 2006/42/EC
- 11 Part number
- 12 Year of manufacture
- 13 Power consumption

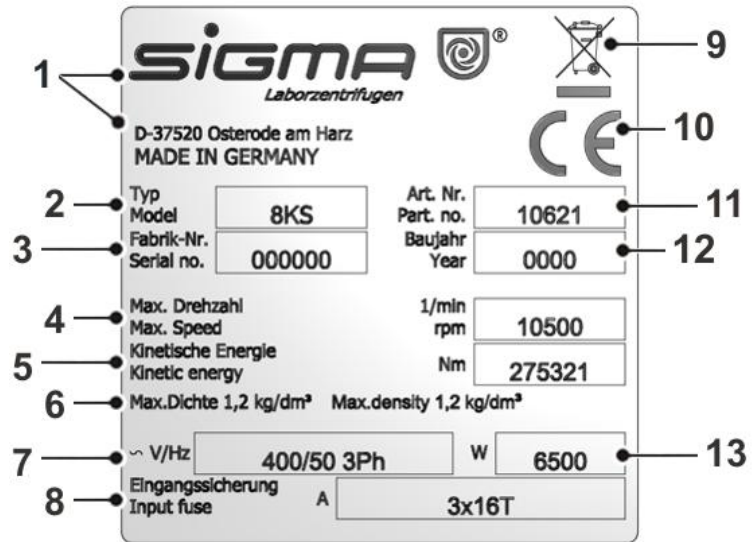

Fig. 5: Example of a name plate

### 2.1.3 Mains plug

The centrifuge is equipped with a 5-pin Cekon plug (16 A).



Fig. 6: 5-pin Cekon plug, 16A



**NOTE**

If the centrifuge is operated within a different power supply network, it may be necessary to replace the mains power plug.  
The rotary field is of no importance when replacing the plug.



**DANGER**

Work on the power supply system must only be performed by certified electricians!

## **2.2 Mode of operation**

### **2.2.1 Centrifugation principle**

Centrifugation is a process for the separation of heterogeneous mixtures of substances (suspensions, emulsions, or gas mixtures) into their components. The mixture of substances, which rotates on a circular path, is subject to centripetal acceleration that is several times greater than the gravitational acceleration.

Centrifuges use the mass inertia inside the rotor chamber for separating the substances. Due to their higher inertia, particles or media with a higher density travel outwards. In doing so, they displace the components with a lower density, which in turn travel towards the centre.

The centripetal acceleration of an object inside a centrifuge, as the effect of centripetal force, depends on the distance between the object and the axis of rotation as well as on the angular velocity. It increases linearly as a function of the distance with regard to the axis of rotation and quadratically as a function of the angular velocity. The bigger the radius in the rotor chamber is and the higher the speed is, the higher the centripetal acceleration is. However, the forces acting on the rotor also increase.

### **2.2.2 Area of application**

Depending on the area of application of the centrifuge and also on the particle size, solids content, and volume throughput of the mixture of substances that is to be centrifuged, there are different types of centrifuges.

The areas of application go from household use as a salad spinner or honey separator up to specialised technical applications in the clinical, biological, or biochemical context:

- For numerous clinical examinations, cellular material must be separated from the liquid to be analysed. The normal separation process can be sped up considerably by using laboratory centrifuges.
- In the metal-working industry, centrifuges are used for separating oil from metal cuttings. Dairies use centrifuges in order to separate cow's milk into cream and low-fat milk.
- Particularly big centrifuges are used in the sugar industry for separating the syrup from the crystalline sugar.
- Ultracentrifuges are predominantly used in biology and biochemistry in order to isolate particles, e.g. viruses. They are specifically designed for high speeds up to 500,000 rpm. The rotor moves in a vacuum in order to avoid air friction.



### 2.2.2.1 Speed, radius, and relative centrifugal force

The acceleration  $g$ , which the samples are subject to, can be increased by increasing the radius in the rotor chamber and by increasing the speed. These three parameters are interdependent and linked with each other via the following formula:

$$\text{Relative centrifugal force RCF} = 11.18 \times 10^{-6} \times r \times n^2$$

$r$  = radius in cm

$n$  = speed in rpm

RCF without any dimension

If two values are entered, the third value is determined by way of the stated formula. If, afterwards, the speed or the radius is changed, the resulting relative centrifugal force will be recalculated automatically by the control unit. If the RCF is changed, the speed will be adapted while the specified radius is maintained.

The speed-gravitational-field-diagram provides an overview of the relationship between speed, radius, and RCF (see chapter 11.2 - "**Speed-gravitational-field-diagram**").

### 2.2.2.2 Density

The laboratory centrifuge is suitable for the separation of constituents of different densities in mixtures with a maximum density of  $1.2 \text{ g/cm}^3$ . All information concerning the speed of rotors and accessories refers to liquids with a density corresponding to this specification. If the density is above this value, the maximum permissible speed of the centrifuge must be reduced based on the following formula:



$$n = n_{max} \times \sqrt{(1,2 / Rho)}$$

$Rho$  = density in  $\text{g/cm}^3$

## 3 Safety

### 3.1 Marking of the unit







The following symbols are used for SIGMA centrifuges:

	Dangerous voltage
	Attention, consult the instruction manual
	On (Power)
	Off (Power)
	Protective earth (ground)
	Earth (ground)
	Unplug the mains plug
	Caution! Risk of bruising
	Arrow indicating the direction of rotation
	Hot surface
	CE mark in compliance with the directive 2006/42/EC
	Do not dispose as part of domestic waste



### 3.2 Explanation of the symbols and notes

SIGMA operating manuals use the following names and symbols to indicate hazards:

 <b>DANGER</b>	<p>This symbol stands for a <b><u>direct</u></b> hazard to the life and health of persons.</p> <p>Non-observance of these symbols <b><u>causes</u></b> serious health problems up to life-endangering injuries.</p>
 <b>DANGER</b>	<p>This symbol stands for a <b><u>direct</u></b> hazard to the life and health of persons due to electrical voltage.</p> <p>Non-observance of these symbols <b><u>causes</u></b> serious health problems up to life-endangering injuries.</p>
 <b>WARNING</b>	<p>This symbol stands for a <b><u>potential</u></b> hazard to the life and health of persons.</p> <p>Non-observance of these symbols <b><u>can</u></b> cause serious health problems up to life-endangering injuries.</p>
 <b>WARNING</b>	<p>This symbol stands for a <b><u>potential</u></b> hazard to the life and health of persons due to biological substances.</p> <p>Non-observance of these symbols <b><u>can</u></b> cause serious health problems up to life-endangering injuries.</p>
 <b>CAUTION</b>	<p>This symbol indicates a potentially hazardous situation</p> <p>Non-observance of these notes can cause minor injuries or damage to property.</p>
 <b>NOTE</b>	<p>This symbol indicates important information.</p>

### 3.3 Responsibility of the operator

The operator is responsible for authorising only qualified personnel to work on the centrifuge (see chapter 3.4 - "**Operating personnel**").

The areas of responsibility of the personnel concerning the operation, maintenance, and care of the unit must be clearly defined.

The safety-conscious work of the personnel in compliance with the operating manual and the relevant EC and national health and safety regulations as well as with the accident prevention regulations must be checked at regular intervals (e.g. every month).

Under the international rules for health and safety at work, the operator is obliged to:

- take measures in order to prevent all danger to life or health during work.
- ensure that centrifuges are operated properly and entirely as intended (see chapter 1.2 - "**Intended use**").
- take protective measures against fire and explosion when working with hazardous substances.
- take measures for the safe opening of centrifuges.

### 3.4 Operating personnel

Persons operating the unit must

- be familiar with the fundamental regulations concerning workplace safety and accident prevention
- have read and understood this operating manual (and in particular the safety sections and warning notes) and confirmed this with their signature.

### 3.5 Informal safety instructions

- This operating manual is a part of the product.
- The operating manual must be kept at the location of use of the centrifuge. Ensure that it is accessible at all times.
- The operating manual must be handed over to any subsequent owner or operator of the centrifuge.
- Any changes made must be added to the operating manual.
- In addition to the operating manual, the general and local rules and regulations concerning the prevention of accidents and the protection of the environment must also be supplied.
- Safety and danger indications on the centrifuge must be kept readable at all times. If necessary, they must be replaced.

## 3.6 Safety instructions

### 3.6.1 Electrical safety

To reduce the risk of electrical shock, the centrifuge uses a three-wire electrical cord and plug to connect the equipment to earth-ground. To preserve this safety feature:



**DANGER**

- Ensure that the wall socket is properly wired and grounded.
- Check that the mains voltage agrees with the nominal voltage listed on the name plate.
- Do not place vessels containing liquid on the centrifuge lid or within the safety distance of 30 cm around the centrifuge. Spilled liquids may get into the centrifuge and damage electrical or mechanical components.
- Work on the power supply system must only be performed by certified electricians.
- Inspect the electrical equipment of the unit regularly. Defects such as loose or burnt cables must be eliminated immediately.

### 3.6.2 Mechanical safety

In order to ensure the safe operation of the centrifuge, observe the following:



**WARNING**

- Do not open the lid when the rotor is in motion!
- Do not reach into the rotor chamber when the rotor is in motion!
- Do not use the centrifuge if it was installed incorrectly.
- Do not use the centrifuge without panels.
- Do not use the centrifuge if the rotors and inserts show signs of corrosion or other defects.
- Only use the centrifuge with rotors and accessories that have been approved by the manufacturer. In case of doubt, contact the manufacturer (see chapter 7.3 - "**Service contact**").
- Do not hold your fingers between the lid and the housing when closing the lid. Risk of crushing!
- Defective lid relieving devices could cause the centrifuge lid to fall (contact the service department, if necessary). Risk of crushing!
- Do not hit or move the centrifuge during its operation.
- Do not lean against or rest on the centrifuge during its operation.
- Do not spin any substances that could damage the material of the rotors and buckets of the centrifuge in any way. Highly corrosive substances, for example, damage the material and affect the mechanical strength of the rotors and buckets.
- Stop the centrifuge immediately in the event of a malfunction. Eliminate the malfunction (see chapter 7 - "**Malfunctions and error correction**") or inform the service department of Sigma Laborzentrifugen GmbH (see chapter 7.3 - "**Service contact**").
- Ensure that all repairs are performed only by authorised and specialised personnel.

### 3 Safety



**WARNING**

- Prior to any start-up, check the centrifuge, rotor, and accessories for signs of damage that can be discerned from the outside. Special attention must be paid to all of the rubber parts (e.g. motor cover, lid seal, and adapters) in terms of visible structural changes. Defective parts must be replaced immediately.
- Open the centrifuge when it is not in use so that moisture can evaporate.

#### 3.6.3 Fire prevention



**DANGER**

- Do not spin explosive or inflammable substances.
- Do not use the centrifuge within hazardous locations.

#### 3.6.4 Chemical and biological safety

If pathogenic, toxic, or radioactive samples are intended to be used in the centrifuge, it is in the responsibility of the user to ensure that all necessary safety regulations, guidelines, precautions, and practices are adhered to accordingly.



**DANGER**

- Infectious, toxic, pathogenic, and radioactive substances may only be used in special, certified containment systems with a bio-seal in order to prevent the material from being released.
- Take suitable precautions for your own safety if there is a risk of toxic, radioactive, or pathogenic contamination
- Materials that chemically react with each other with a high level of energy are prohibited.



**WARNING**

- Keep informed about local measures to avoid harmful emissions (depending on the substances to be centrifuged).
- Protective clothing is not required for the operation of the centrifuge. The materials to be centrifuged may, however, require special safety measures (e.g. centrifugation of infectious, toxic, radioactive, or pathogenic substances).

### 3.6.5 Safety instructions for centrifugation

For safe operation, observe the following before starting the centrifuge:



**WARNING**

- Ensure that the centrifuge was set up properly (see chapter 5 - "**Set-up and connection**").
- Maintain a safety distance of at least 30 cm (12 inches) around the centrifuge.
- Do not store any dangerous goods in the centrifuge area.
- Do not stay in the safety area longer than what is absolutely necessary for the operation of the centrifuge.
- Only use the centrifuge with rotors and accessories that have been approved by the manufacturer. We explicitly warn against the use of equipment of poor quality. Breaking glass or bursting vessels can cause dangerous imbalances at high speeds
- Ensure that rotor and buckets are correctly fitted (see chapter 6.2.2.1 - "**Installation of the rotor**").
- Observe the instructions on the installation of accessories (see chapter 6.2.2.3 - "**Installation of accessories**").
- The rotor must be loaded symmetrically at equal weights.
- If liquids with a density  $> 1.2 \text{ g/cm}^3$  are used, reduce the speed (see chapter 2.2.2.2 - "**Density**").
- Do not use the centrifuge if the rotor is loaded asymmetrically.
- Do not use the centrifuge with tubes that are excessively long.



**WARNING**

### 3.6.6 Resistance of plastics

Chemical influences have a strong effect on the polymeric chains of plastics, and, therefore, on their physical properties. Plastic parts can be damaged if solvents, acids, or alkaline solutions are used.



**NOTE**

- Refer to the resistance data (see chapter 11.5 - "**Resistance data**")!

### 3 Safety

#### 3.6.7 Rotors and accessories

##### 3.6.7.1 Lifting and carrying rotors



All swing-out rotors applicable for this centrifuge and the angle rotor 12510 weigh more than 18 kg.

- Always lift the rotors with a lifting device or with a sufficient number of people helping you.

##### 3.6.7.2 Service life

The rotors and accessories have a limited service life.



- Perform regular checks (at least once per month) for safety reasons!
- Pay special attention to changes, such as corrosion, cracks, material abrasion etc.
- After 10 years, they must be inspected by the manufacturer.
- After 50,000 cycles, the rotor must be scrapped for reasons of safety.
- If other data concerning the service life are engraved on the rotor or bucket, these data shall apply accordingly. For example, a bucket with the engraving "max cycles = 10,000" has a service life of 10,000 cycles, and a rotor with the engraving "Exp.Date 02/15" must be scrapped in February 2015 at the latest (see figure).



Fig. 7: Different service life – engraving on the bucket/rotor



**NOTE**

- Refer to the table of rotors and accessories with a different service life (see chapter 11.4 - "**Table of the service life of rotors and accessories** ")!



## **3.7 Safety devices**

### **3.7.1 Lid lock device**

The centrifuge can only be started when the lid is properly closed. The electrical lock must be locked. The lid can only be opened when the rotor has stopped. If the lid is opened by way of the emergency release system during operation, the centrifuge will immediately switch off and decelerate brakeless. If the lid is open, the drive is completely separated from the mains power supply, i.e. the centrifuge cannot be started (see chapter 7.1.1 - "**Emergency lid release**").

### **3.7.2 Standstill monitoring system**

Opening of the centrifuge lid is only possible if the rotor is at a standstill. This standstill is checked by the microprocessor.

### **3.7.3 System check**

An internal system check monitors the data transfer and sensor signals with regard to plausibility. Errors are detected with extreme sensitivity and displayed as error messages in a dialog box (see chapter 7.2 - "**Table of error codes**").

### **3.7.4 Earth conductor check**

For the earth conductor check, there is an equipotential bonding screw on the rear panel of the centrifuge (see chapter 2.1.1 - "**Functional and operating elements**"). An earth conductor check can be carried out by authorized and specialized personnel using a suitable measuring instrument. Please contact the Sigma service department (see chapter 7.3 - "**Service contact**").

### **3.7.5 Imbalance monitoring system**

A dialog box may pop up or emit a sound signal in order to indicate that the centrifuge is in the inadmissible imbalance range. If the rotor is loaded unevenly, the drive will be switched off in the acceleration phase or during the run.

### **3.7.6 Temperature monitoring system**

If the temperature inside the rotor chamber rises above 50°C, the drive system will be switched off automatically. The centrifuge cannot be restarted until it has cooled.

### **3.7.7 Rotor monitoring system**

When a rotor number and, if applicable, a bucket number are selected, the computer will automatically check whether the entered speed or the entered gravitational field are permissible for the selected rotor.

### 3.8 Measures in the event of hazards and accidents



DANGER

- If an emergency arises, switch off the centrifuge immediately!
- If in doubt, call the emergency doctor!

### 3.9 Remaining hazards

The unit was built state- of- the- art and according to the accepted safety rules. However, danger to life and limb of the operator, or of third parties, or impairments of the unit or other material assets cannot be completely excluded when the unit is being used.

- Use the unit only for the purpose that it was originally intended for (see chapter 1.2 - "**Intended use**").
- Use the unit only if it is in a perfect running state.
- Immediately eliminate any problems that can affect safety.



## 4 Storage and transport

### 4.1 Dimensions and weight

	Sigma 8KS / 8KBS
Height (mm):	980
Height with open lid (mm):	1 690
Width (mm):	810
Depth (mm):	910
Weight (kg):	420

### 4.2 Storage conditions

The centrifuge can be stored in its original packaging for up to a year.

- Store the centrifuge only in dry rooms.
- The storage temperature must be above  $-20^{\circ}\text{C}$ .
- If you would like to store it for more than one year, or if you intend to ship it overseas, please contact the manufacturer.

### 4.3 Notes on transport

- Always lift the centrifuge with a lifting device (e.g. a fork lift).
- When lifting the centrifuge, always reach under the centrifuge from the rear side.



**CAUTION**

The centrifuge weighs approx. 420 kg!

- For transport, use suitable packaging and, if at all possible, the original packaging(see chapter 4.4 - "**Packaging**").

## 4 Storage and transport

---

### 4.4 Packaging

The centrifuge is packaged in a wooden crate.

- After taking off the lid, remove the side panels.
- Remove the packaging material.
- Lift the centrifuge upwards with a lifting device (e.g. a forklift) to lift it safely. Always reach under the centrifuge from the rear side.



**CAUTION**

The centrifuge weighs approx. 420 kg!

- Retain the packaging for any possible future transport of the centrifuge.

## 5 Set-up and connection

### 5.1 Installation site

Operate the centrifuge only in closed and dry rooms.

All the energy supplied to the centrifuge is converted into heat and emitted to ambient air.

- Air cooled centrifuges: Ensure sufficient ventilation.



**NOTE**

The centrifuge 8KS / SKBS with an air-cooled compressor should not be set up with its left side against a wall, since otherwise the hot air, which is emitted out the back, will be drawn in again as fresh air for cooling. As a result, the unit will switch off due to overheating (see chapter 7.2 - "**Table of error codes**").

- Water cooled centrifuges: Provide sufficient water throughput.
- Do not position the centrifuge near heat generators.
- Avoid direct sunlight (UV radiation).
- During transport from cold to warmer places, condensational water will collect inside the centrifuge. Allow sufficient time for drying (min. 24 h) before using the centrifuge again.

### 5.2 Set-up and alignment of the centrifuge



**DANGER**

Ensure that the centrifuge is disconnected from the power supply during the set-up and alignment.



**NOTE**

Pay attention to the layout plan (see chapter 11.7 - "**Layout plan**")!

## 5 Set-up and connection

### 5.2.1 Set-up

- Transport the centrifuge as closely as possible to the installation site with a lifting device (e.g. forklift).
- Set the centrifuge down.
- To place the centrifuge on the castors, open the front door with the supplied square spanner (part no. 930 114) by turning it clockwise by 90°. Open the front door to the left in order to access the two locking screws located at the front.
- Loosen the two hexagon lock nuts with the open spanner, size 24 (part no. 930 024), and screw in the locking screws with the open spanner, size 8/10 (part no. 930015), in the anticlockwise direction up to the stop until the adjustment feet are completely relieved of the load.
- Loosen the lock nuts of the two locking screws on the back from the side and from below with the open spanner, size 24 (part no. 930 024). Then, screw in the locking screws anticlockwise with the open spanner, size 13/14 (part no. 930 013), until the adjustment feet are completely relieved of the load.
- Transport the centrifuge on the castors to the installation site.



**CAUTION**

Do not use the lid handle to move the centrifuge because it could break off!



**CAUTION**

The castors of the centrifuge are made of steel without any plastic coating. Damage to the surface of the floor cannot be excluded.

### 5.2.2 Alignment



**DANGER**

For reasons of safety, the centrifuge must not be operated while it is set up on its castors!



**NOTE**

The centrifuge must be set-up stably and horizontally at the installation site.

- Set the centrifuge on its adjustable feet (see (see chapter 5.2.1 - "**Set-up**") in reverse order) To do so, turn all of the feet clockwise by hand until they touch the ground. Then, perform approximately two more clockwise turns with the open spanner until the castors are suspended in the air.

- Open the lid with the emergency lid release system. To do so, lift off the plugs on the left side (e.g. with a screwdriver) and unlock the lid locks by turning them clockwise with the supplied square spanner (see chapter 7.1.1 - "Emergency lid release")
- Align the centrifuge with a spirit level in two directions.
- Tighten the four lock nuts and close the front door.
- Plug in the mains power plug.

- 1 Locking screw
- 2 Lock nut



*Fig. 8: Alignment at the front*

- 3 Adjusting foot
- 4 Castor



*Fig. 9: Alignment at the back*

## 5 Set-up and connection

### 5.3 Power supply

#### 5.3.1 Connection



**DANGER**

The operating voltage on the name plate must correspond to the local supply voltage!

SIGMA laboratory centrifuges are units of safety class I. The centrifuges of the type 8KS and 8KBS have a five-wire power cord (2.5 m) with a 5-channel Cekon-plug (16 A). Behind the front door there are three fuses with a rocker switch.

#### 5.3.2 Fuses

Typically, the centrifuges must be protected on-site with 16 Amp L or B fuses.

#### 5.3.3 Power isolating device

The electrical installation of the building must include a power isolating device in the form of a switch or circuit breaker. This device must be located near the centrifuge. Furthermore, it must be easily accessible for the operator and marked as the power isolating device for the centrifuge.

### 5.4 Condensate drain

The condensate drain is used to drain the condensate off that forms in the rotor chamber during the centrifugation. It consists of a hose with a plastic valve. This hose runs from the rotor chamber to a point on the left behind the front door of the centrifuge.



**WARNING**

- Do not open the condensate drain unless the rotor is at a complete standstill.

#### Draining the condensate off

- Unplug the mains power plug.
- Open the front door with the supplied plastic wrench (order no. 930 114).
- Connect the supplied hose connector and drain the condensate.
- Disconnect the hose connector by pressing the unlocking button.

**i**

**NOTE**

At the installation site, the condensate drain can be laid to the outside (see figure).

- 1 Drain outside of the centrifuge
- 2 Hose (part no. 80415)
- 3 Hose connector (unblocks the drain when connected)
- 4 Unlocking button
- 5 Plug (to be removed prior to the installation)
- 6 Centrifuge door (front, left side)
- 7 Clamp
- 8 Quick coupling
- 9 Lock nut (fasten by hand)
- 10 Condensate – rotor chamber

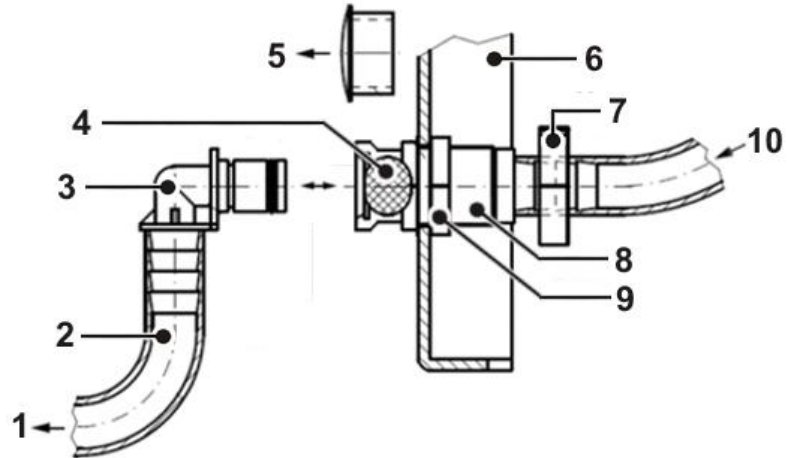

Fig. 10 Laying the condensate drain to the outside

## 5.5 Special equipment: water cooling system

Centrifuges with water cooling are equipped with a special refrigeration unit with a refrigerant (CFC-free), modified electronic system, and a special software version. The housing of the GMP version is completely closed. All of the other units have vent slots for the motor and electronic power system.

### Operating conditions

- The centrifuge must only be operated with media-neutral water of drinking water quality (hardness <8) or with another suitable refrigerant. We recommend using a filter (to be provided by the customer).
- The operating pressure of the water must be between 1.5 and 5 bar. We recommend using a pressure reducer (to be provided by the customer).
- The maximum flow rate depends on the operating conditions (e.g. speed and rotor temperature). The minimum cooling water consumption at maximum power is approximately 5 l/min. At a standstill, the water supply is stopped by a solenoid valve. In the case of the GMP version (ref. no. 10857), the valve is opened in two steps:
  1. reduced flow, only for the internal air cooler
  2. unlimited flow, when the compressors are running.
- The maximum temperature at the water inlet is 20°C. The lower the water temperature, the more efficient the cooling.
- The centrifuge is equipped with a 3/4-inch water connector .

- 1 Connector for the cooling water inlet
- 2 Connector for the cooling water outlet



Fig. 11:  
Connections for the water cooling system



## 6 Using the centrifuge

### 6.1 Initial start-up



**DANGER**

- Before the initial start-up, please ensure that your centrifuge is properly set up and installed (see chapter 5 - "**Set-up and connection**").

### 6.2 Switching the centrifuge on

- Press the mains power switch.  
The display then illuminates. The centrifuge is ready for operation.

#### 6.2.1 Opening and closing the lid

The lid can be opened if the centrifuge is at a standstill and if the lid key is illuminated.

- Press the lid key in order to open the lid.  
The centrifuge cannot be started if the lid is opened.
- To close, press with both hands slightly on the lid until both electrical locks are locked.



**WARNING**

Do not place your fingers between the lid and the housing when closing the lid. Risk of crushing!

#### 6.2.2 Installation of rotors and accessories



**WARNING**

All swing-out rotors applicable for this centrifuge and the angle rotor 12510 weigh more than 18 kg.

- Always lift the rotors with a lifting device or with a sufficient number of people helping you.

## 6 Using the centrifuge

### 6.2.2.1 Installation of the rotor

- Open the centrifuge lid by pressing the lid key.
- Unscrew the rotor tie-down screw from the motor shaft (counter-clockwise).
- Lower the rotor with its central bore straight down onto the motor shaft.
- Turn the adapter end of the motor shaft anti-clockwise with the supplied hexagon socket key (part no. 930 050) and tighten the internal thread of the rotor with 20 Nm with the rotor wrench (size 17/19, part no. 930 018).



**WARNING**

After frequent use, the rotor tie-down screw must be loosened by some turns, the rotor has to be lifted and fastened again. This must be done once a day or after 20 cycles. This ensures a proper connection between the rotor and the motor shaft.

- Follow the safety instructions and hazard warnings (see chapter 3 - "Safety")!

### 6.2.2.2 Installation of angle rotors with a hermetically sealed lid

- Lower the rotor onto the motor shaft.
- Turn the adapter end of the motor shaft anti-clockwise with the supplied hexagon socket key (part no. 930 050) and tighten the internal thread of the rotor with 20 Nm with the rotor wrench (size 17/19, part no. 930 018).



**NOTE**

- Slightly grease the rotor and lid seals after cleaning.

- Screw the rotor cover onto the rotor and tighten it with the supplied tool no. 17985 by hand.
- The rotors can be installed or removed with a closed lid after loosening the rotor tie-down screw.
- Follow the safety instructions and hazard warnings (see chapter 3 - "Safety")!



**WARNING**

The lid screw serves for the fastening of the lid onto the rotor only, not for the fastening of the rotor onto the motor shaft!

### 6.2.2.3 Installation of accessories

- Only use inserts that are suitable for the rotor (see chapter 11.1 - "Range of accessories").
- All four buckets of the swing-out rotor need to be installed when spinning.
- Always load the rotors symmetrically to avoid imbalance.

#### Centrifugation with different tube sizes

Working with different tube sizes is possible. In this case, however, it is very important that the inserts are loaded symmetrically (see figure).



Fig. 12: Permissible loading of the swing-out rotor with different tube sizes

#### Centrifugation with low capacity

The tubes must be installed symmetrically so that the buckets and their inserts are loaded evenly (see figure).

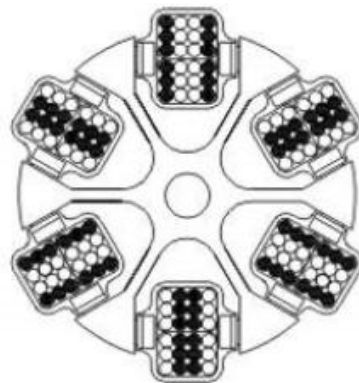

Fig. 13: Permissible loading of the swing-out rotor with low capacity

## 6 Using the centrifuge

---

### 6.2.2.4 Adapters

In order to ensure easy handling, even if vessels of various sizes are used, carrier systems were developed.

- Load the opposite adapters with the same number of vessels and with the same weights in order to avoid imbalance.
- If all of the compartments of a carrier are not used, the buckets must be loaded evenly. Loading the edges of a bucket only is not permissible.

### 6.2.2.5 Tubes

- Load the tubes outside of the centrifuge. Liquids in the buckets or multiple carriers cause corrosion .
- Fill the tubes carefully and arrange them according to their weight. Imbalances result in the excessive wear of the bearings.
- In high-speed angle rotors, the vessels must be filled up to their useful volume (= the volume stated for the vessel). If the vessels are only partially filled, they will deform. This may result in leaks at the seals that may become loose.
- When using glass tubes, the maximum value of 4,000 x g must not be exceeded (except special high-strength glass tubes; please refer to the information provided by the manufacturer).
- Follow the safety instructions and hazard warnings (see chapter 3 - "**Safety**")!

### 6.2.2.6 Blood bag systems

- All six places on the rotor must be loaded with buckets.
- It is required to fill just two opposite buckets must be filled with one adapter for blood bags and two blood bag systems each.
- The opposite buckets, including the filled blood bag systems, must have an equal weight. If the number of blood bags is uneven, a balance adapter (part no. 17765 for 13865, part no. 17766 for 13866) must be used. For taring, several balance weights are available (see chapter 11.1 - "**Range of accessories**").
- The blood bags must be put into opposite buckets in a mirror-inverted way (see figure).
- In both adapter compartments, the main blood bag must be situated towards the middle. The opposite bucket must be loaded correspondingly (see figure, item 1).
- When using smaller bag systems or in the case of incompletely filled blood bags, adapters (e.g. part no. 17750) must be inserted together with the blood bag systems. This will help to avoid any slipping of the bags, which could result in an imbalance.

- 1 Proper loading  
2 Possible loading  
3 Improper loading

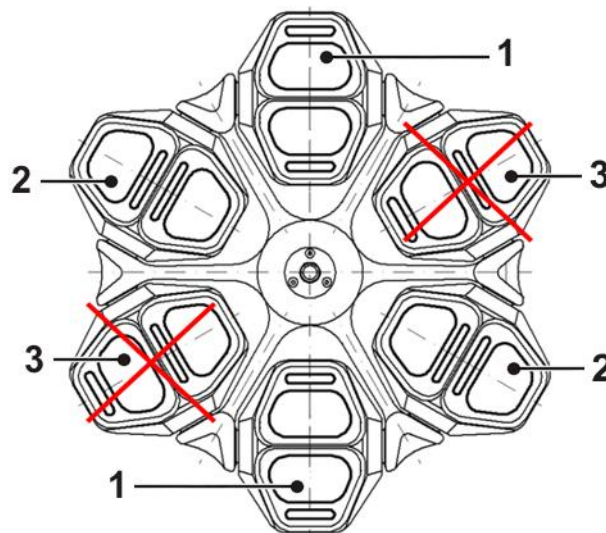

Fig. 14: Loading of blood bag systems



**WARNING**

The service life of the adapters for blood bags no. 13864, 13865 and 13866 is limited. Refer to the table of rotors and accessories with a different service life (see chapter 11.4 - "**Table of the service life of rotors and accessories** ")!

## 6 Using the centrifuge

### 6.3 Control system "Spincontrol S"

#### 6.3.1 User interface

The centrifuge is operated via three buttons with integrated light-emitting diodes and one function knob. The display is divided into several different fields. The various functions of the system can be called up by pressing and turning the function knob.

- 1 Start key
- 2 Display
- 3 Function knob
- 4 Stop key
- 5 Lid key

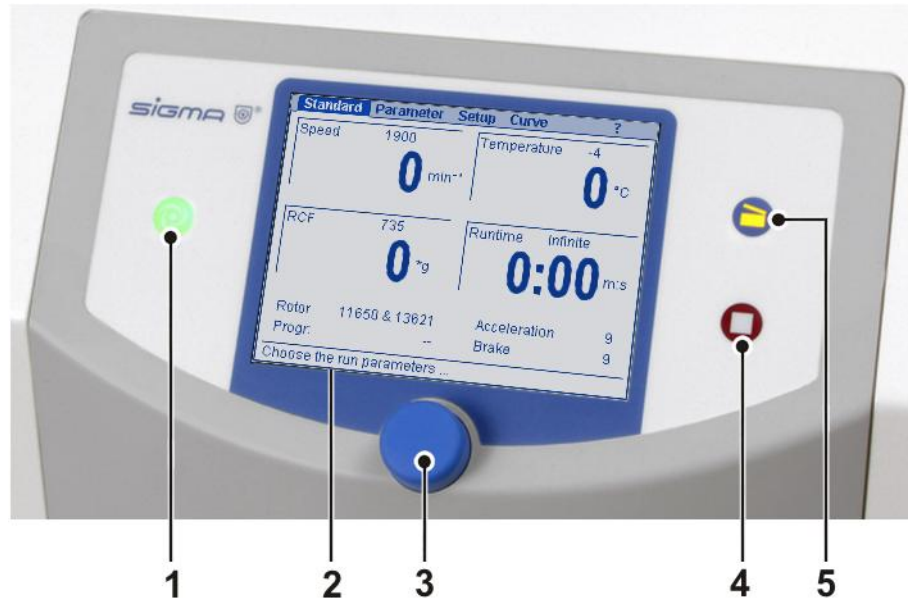

Fig. 15: User interface of the "Spincontrol S" control system

#### Display

The centrifuge display has the following display fields:

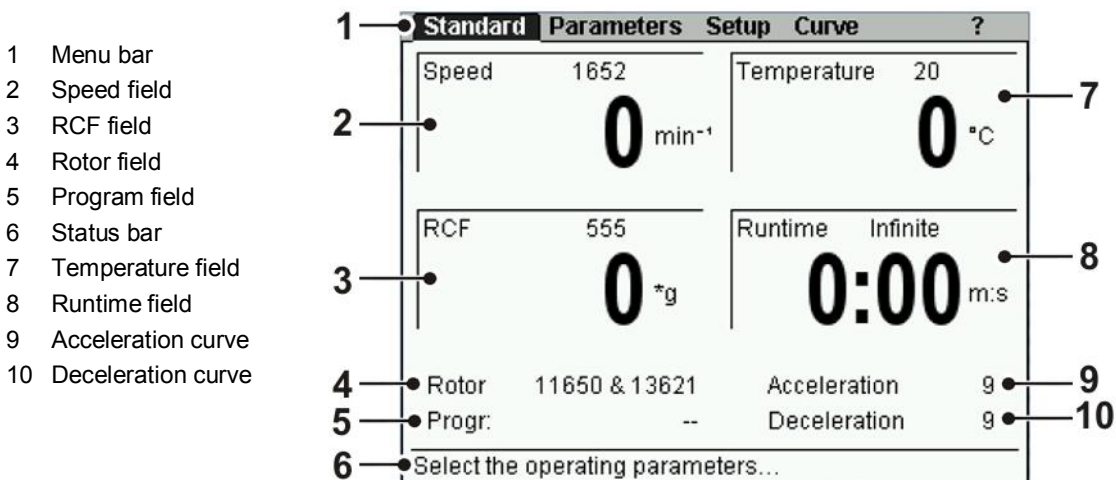

Fig. 16: Display of the "Spincontrol S" control system



## 6.3.2 Manual mode

### 6.3.2.1 Starting a centrifugation run

The centrifuge is ready for operation when the start key is illuminated.

- Press the start key in order to start a centrifugation run.

### 6.3.2.2 Interrupting a centrifugation run

- Press the stop key in order to interrupt a centrifugation run. The centrifugation run will be terminated prematurely.

#### Quick stop

- Press the stop key for more than three seconds.

The centrifuge decelerates with the maximum deceleration curve.

After a quick stop, the centrifuge lid must be opened before a new centrifugation run can be started.

A quick stop can also be triggered during a normal deceleration, e.g. in order to speed up the deceleration.

When a quick stop is triggered, "Quick stop" will be displayed in the speed field.

### 6.3.2.3 Interrupting a deceleration process

- Press the start key during a deceleration process in order to interrupt it and to restart the centrifuge.

### 6.3.2.4 Selection, display, and modification of data

The standard menu is displayed.

- Turn the function knob in order to select a field. The selected field is inverted.
- Press the function knob. The display starts to flash and the modification mode is active.
- Turn the function knob in order to modify the set value of the selected field.
- Press the function knob again to confirm the entry and to quit the modification mode.

## 6 Using the centrifuge

### 6.3.2.5 Standard menu

The standard menu is displayed a few seconds after the centrifuge has been switched on. The following parameters can be displayed and modified.

Standard	Parameters	Setup	Curve	?
Speed	1566	Temperature	-4	
	<b>0</b> min <sup>-1</sup>		<b>0</b> °C	
RCF	515	Runtime	0:02:00	
	<b>0</b> *g	<b>2:00</b>	m:s	
Rotor	11650 & 13450	Acceleration	9	
Progr:	--	Deceleration	9	
Select the operating parameters...				

Abb. 17: Standard menu

#### Speed

In the upper section of the field, the set speed of the centrifuge is displayed. The actual speed is displayed below this value. The values are stated in revolutions per minute (rpm) and depend on the RCF values (see chapter 2.2.2.1 - "**Speed, radius, and relative centrifugal force**"). The maximum speed values depend on the rotor that is used.

#### Relative centrifugal force (RCF)

The relative centrifugal force is the acceleration that the sample is subjected to. The set value of this parameter is displayed in the upper section of this field, with the actual value shown below. The values are stated in g (gravitational acceleration) and depend on the speed value (see chapter 2.2.2.1 - "**Speed, radius, and relative centrifugal force**"). The maximum RCF values depend on the rotor that is used.

#### Temperature

The set temperature is displayed in the upper section of the field, with the current rotor chamber temperature shown below. Temperatures between -20 °C and +40 °C can be preselected.



#### NOTE

The centrifuge is not equipped with an active heater. As a result, temperatures above room temperature depend on the air friction of the running motor.





### Runtime

The set runtime is displayed in the upper section of this field, with the remaining runtime shown below. The runtime is defined as the period from the start of the centrifuge to the beginning of the deceleration phase. The maximum value is 99 h 59 min 59 sec.

In the "Setup" menu, one can specify that the counting of the runtime is not to be started until the set speed is reached (see chapter 6.3.2.7 - "**Setup menu**"). In this case, the symbol "⌚!" appears in the runtime field.

### Continuous run

During the continuous run, the runtime of the centrifuge is unlimited and must be stopped manually. The centrifuge accelerates during the continuous run until the set speed is reached.

- Select the field "Runtime" and confirm the selection. The display flashes when it is activated.
- Turn the function knob from the time 0:00:10 anti-clockwise or from the time 99:59:59 clockwise. "Infinite" will be displayed. After the start of the centrifuge, the elapsed time will be displayed.
- Deactivate the continuous run by pressing the stop key or by entering a specific runtime.

### Short run

A short run can be started if no run is active.

- Keep the start key pressed during the short run.

During the short run, the centrifuge accelerates with the maximum acceleration curve 9 until the maximum speed of the rotor is reached. The runtime is counted and in the speed field the message "Short run" flashes.

When the start key is released, the centrifuge decelerates to a standstill based on the maximum deceleration curve.



#### NOTE

The parameters speed, RCF, temperature, and runtime can be changed during the centrifugation.

## 6 Using the centrifuge

### Rotor: rotor selection list/ automatic rotor identification

This field shows the rotor that is currently being used.

- Select the field "Rotor" and confirm the selection. A list with all of the possible rotors without buckets is displayed.
- Select the desired rotor. All of the possible rotor/bucket combinations and additional information for each combination will be displayed.
- Select a rotor/bucket combination and confirm the selection. Press the function knob in order to accept the data.

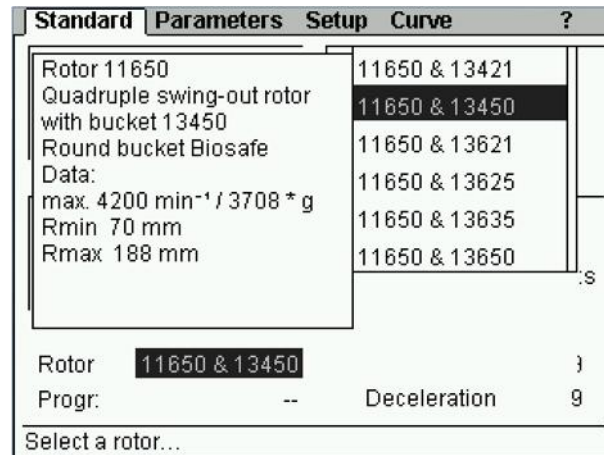

Fig. 18: Rotor selection list, here with potential rotor-bucket combinations and additional information

### Identifying and adapting incorrectly set rotors

The centrifuge automatically identifies the rotor that is being currently used.

- If the system identifies a different rotor than the one that is set, and there are no different buckets for this rotor, the rotor input will be adapted automatically. The system will not display a message.
- If the system identifies a different rotor than the one that is set, and if there are different rotor/bucket combinations for this rotor, the system will automatically select the rotor with the lowest speed. The system will display a corresponding message so that the rotor can be selected manually.
- If the system cannot identify the rotor, a message will be displayed. The rotor cannot be used in the centrifuge.

This prevents the maximum permissible speed from being exceeded.

**Progr.: program selection list**

This field in the standard menu shows the program that is currently loaded. When the field is selected, the program list is displayed (for information on how to work with the programs, see chapter 6.3.3 - "Program mode").

The program "RAPID\_TEMP" cannot be deleted (see below).

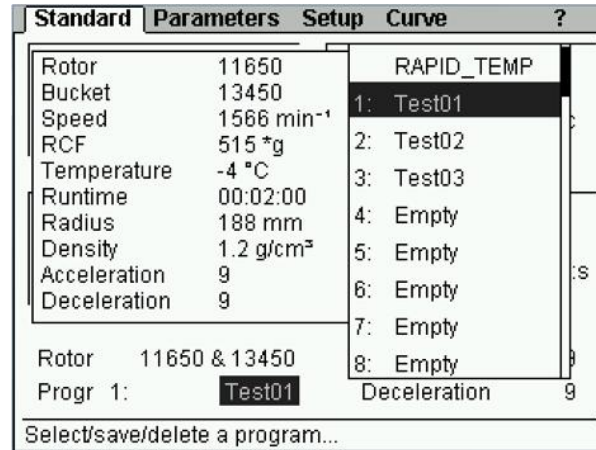

Fig. 19: Program selection list

**Program "RAPID\_TEMP"**

Precooling at a standstill may distort the measurement results and subsequently cause increased wear of the mechanical components. This is why the centrifuge has a special program that precools the centrifuge rapidly under defined conditions:

- Select the option "Progr" in the "Standard" menu and confirm the selection. The program list will be displayed.
- Select the program "RAPID TEMP" on the program list and confirm the selection. The display shows 1/3 of the maximum rotor speed and the corresponding RCF value. The deceleration (brake) and acceleration curves correspond to curve 9 and the runtime field indicates "infinite" (continuous run).

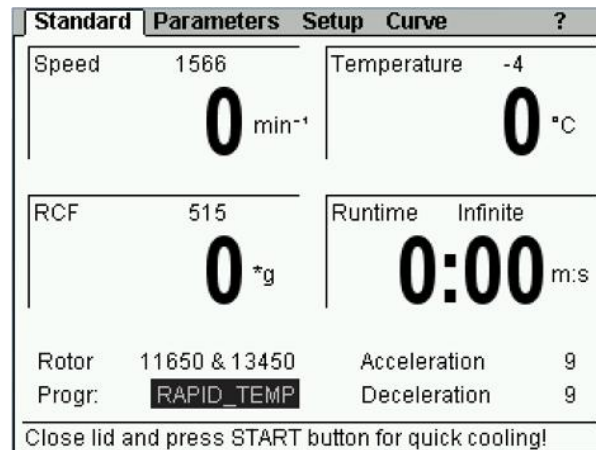

Fig. 20: "RAPID\_TEMP" program



**NOTE**

The program will only be loaded if the actual temperature is above the set temperature.

## 6 Using the centrifuge

- Press the start button in order to start the rapid cooling process.
- During the rapid cooling process, the set temperature can be modified within the range below the actual temperature.

The current status of the program will be displayed on the status bar.

The "RAPID\_TEMP" program will be stopped under the following conditions:

- The set value is reached. In this case, the "RAPID\_TEMP" program stops with a sound signal and the standstill cooling will be activated.
- The stop button is pressed. The "RAPID\_TEMP" program will be stopped prematurely. No message will be issued when the set temperature is reached.
- A parameter is changed (except for the temperature) or another input is made. In this case, the "RAPID\_TEMP" program will be aborted. No message will be issued when the set temperature is reached.

After the stop, the previous program will be reloaded or the changed parameters will be adopted as the new settings.



### NOTE

The automatic lid opening function is suppressed after a rapid cooling process in order to prevent the system from reheating.



### NOTE

The delta T temperature monitoring system (see chapter (see chapter 6.3.2.6 - "**Parameters menu**"), Process) remains inactive as long as the "RAPID\_TEMP" program is active.



### NOTE

If the "RAPID\_TEMP" program is used, the temperature of the unloaded aluminium bucket will be displayed. If samples, which have not been precooled, are placed into the buckets, the displayed temperature will deviate from the actual sample temperature.

### Acceleration

This function is used to select an acceleration curve. One can select a linear rise (curves 0-9) or a quadratic rise (curves 10-19). The acceleration curves 20-29 can be programmed as desired.

Their shape is explained in detail in (see chapter 11.3 - "**Acceleration and deceleration curves**").

### Deceleration (Brake)

This function is used in order to select a curve that decelerates the centrifuge to a standstill. Deceleration curves are inverted images of the acceleration curves and are labelled with identical numbers. Deceleration curve no. 0 represents a brakeless deceleration.

### 6.3.2.6 Parameters menu

The "Parameters" menu is used to specify various conditions for the centrifugation. These conditions are used to monitor the process and to control access to the centrifuge.

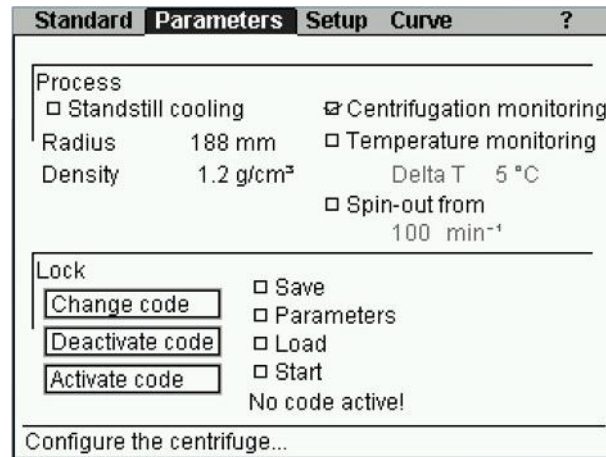

Fig. 21: Parameter menu

### Process

#### Standstill cooling

Depending on the substances to be centrifuged, it may make sense to precool the centrifuge. The precooling prevents the cooled samples in the uncooled centrifuge from heating up to an inadmissible temperature.

If the standstill cooling is activated, the centrifuge starts to precool after it is switched on. In the runtime field, the symbol "❄" is displayed. The lid must be closed.



Unmoved air in the rotor chamber distorts the measuring and control behaviour and causes the compressor to freeze over. At temperatures below 0°C, aqueous liquids will freeze, making sedimentation impossible.

- Ensure that the rotor temperature does not fall below 0 °C if it is at a standstill!



The centrifuge is equipped with the "RAPID\_TEMP" program. This program is used to precool the rotor chamber quickly under defined conditions (see chapter 6.3.2.5 - "**Standard menu**", Program list).

#### Radius

The radius determines the value of the relative centrifugal force (RCF) that the sample is subjected to. Normally, the maximum RCF value is displayed. If the value is reduced manually, a downward facing arrow (↓) will be displayed in the RCF field.

## 6 Using the centrifuge

### Density

This setting is useful for glass vessels. If the density of the liquid to be centrifuged is higher than 1.2 g/cm<sup>3</sup>, the value must be adapted manually. This will reduce the maximum possible final speed (see chapter 2.2.2.2 - "Density"). A downward facing arrow (↓) will be displayed in the speed field. Values between 1,2 and 10.0 g/cm<sup>3</sup> are possible.

### Centrifugation monitoring

The centrifugation monitoring function enables the continuous monitoring of the speed and runtime parameters during the centrifugation.

- Activate the centrifugation monitoring function by clicking.



#### NOTE

If the function is activated during a centrifugation run, the monitoring process will not be started until the start of the next centrifugation run.

The centrifugation monitoring function compares the speed values of the current run with the reference values that are stored in the control unit. After every run, it issues a corresponding message. The runtime is considered faulty if the centrifugation run had to be stopped prematurely.

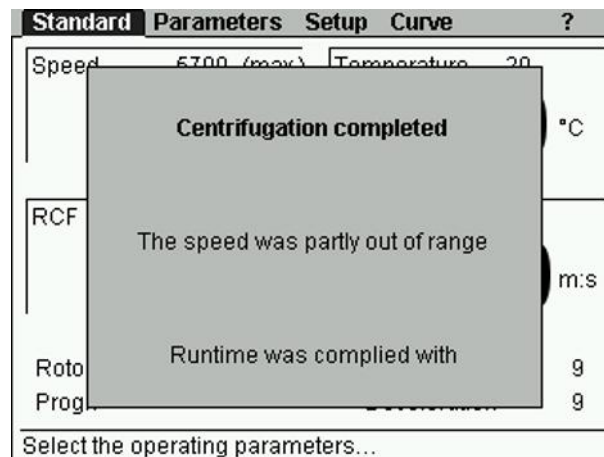

Fig. 22: Example of a centrifugation monitoring message



#### NOTE

Using the centrifugation monitoring system in combination with the free acceleration or deceleration curves may lead to unjustified error messages in some cases.

### Temperature monitoring

The control system includes a temperature monitoring function. If the set temperature difference with regard to the set value deviates from the actual temperature difference, this function will stop the centrifuge and issue an error message.

- Select the temperature monitoring function and confirm the selection.
- Set the desired threshold "delta T" in steps of 1°C or 1°F and confirm the selection.

If the temperature monitoring function is active, the symbol  $\pm$  is displayed in the temperature field of the Standard menu.

In this case, the centrifuge can only be started if the current temperature in the window is between the preset temperature in the Standard menu and the threshold value "delta T".

If the temperature leaves this window during the centrifugation run, an error message will be displayed and the centrifuge will be decelerated to a complete standstill.

### Spin-out from set speed

If this function is active, the drive will be disconnected if the actual speed is below the set speed. As a result, the rotor decelerates and stops in a brakeless manner.



#### NOTE

A spin-out (i.e. brakeless deceleration), in particular with heavy rotors and at high speeds, can take a lot of time! (Depending on the rotor and load, the speed will be reduced by approximately 0.5 to 1 rpm per second).

If the spin-out is active, "+0" is displayed next to the deceleration curve.

- The spin-out can be interrupted by a quick stop or by restarting the centrifuge.

### **Lock**

In order to prevent any unauthorised use of the centrifuge, the following functions can be blocked:

- Saving of programs
- Changing of parameters
- Loading of programs
- Start key

### Blocking a function

- Select the function that is to be blocked. The preceding functions will also be automatically selected (example: If the Parameter function is selected, the Save function will also be selected).
- Select the button "Activate code".
- Enter a four-digit code and confirm the entry.

The blocking is now active. A padlock symbol  will be displayed in the status line.

If changes are made to a blocked function, the system will ask for the code prior to executing the change.



## 6 Using the centrifuge

### Unlocking a function

- Select the button "Deactivate code".
- Enter the code and confirm the entry.

The function is now unblocked.

### Changing the code

- Select the button "Change code".
- Enter the old code and confirm the entry.
- Enter the new code.
- For safety reasons, the code must be entered a second time.

The code is now changed.

### 6.3.2.7 Setup menu

The "Setup" menu can be used to perform basic settings concerning the control system of the centrifuge. It enables the optimum adaptation of the centrifuge to its specific area of application.

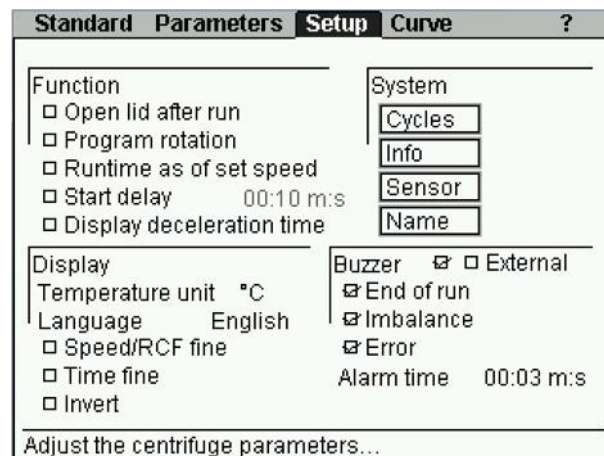

Fig. 23: Setup menu

### **Function**

#### Open lid after run

The automatic lid opening function must be activated so that the lid opens automatically at the end of the operation.



**CAUTION**

When the lid is open, the cooling is not active. The samples may warm up!

#### Program rotation

See chapter 6.3.3.4 - "Automatic program rotation"



#### Runtime as of set speed

If this function is active, the runtime will not be measured until the set speed is reached. The clock symbol "🕒" will be displayed in the runtime field.

#### Start delay

If the start delay function is active, the centrifuge will not start until the preset time has elapsed. The symbol "⌚" will be displayed in the runtime field.

#### Display deceleration time

In the activated mode, the deceleration time will be displayed instead of the runtime during and after the deceleration process. Below the time display, the symbol "🕒" will be displayed. During a deceleration process, the symbol flashes. Once the deceleration is complete, it is displayed in a permanent manner.

### **Display**

#### Temperature unit

- Select between °C (Celsius) and °F (Fahrenheit).

#### Language

Various languages are available.

If a language is selected by mistake, it can be changed on any screen as follows:

- Press and hold the stop key.
- Turn the function knob one notch to the left and then one notch to the right.
- Release the stop key. The window "Language" will be displayed.
- Select the desired language.

#### Speed/RCF fine and time fine

This menu can be used to preselect the set speed in steps of 1 rpm (instead of 100 rpm), the RCF value in steps of 1 x g (instead of 10 x g), and the set time in steps of 1 min or 1 sec (instead of 10 min or 10 sec).



#### **NOTE**

Regardless of the fine adjustment, the step size increases when the function knob is turned quickly.

#### Invert

If this function is activated, the display switches from the standard setting with a bright background and dark writing to a dark background with bright writing.

## 6 Using the centrifuge

---

### **System**

#### Cycles

This field shows the number of cycles as well as the runtime of the rotor and buckets that are currently being used.

#### Info

This menu provides information on the software versions that are used in this centrifuge.

#### Sensor

The sensor mode is reserved for service personnel.



#### **NOTE**

In the menus "Cycles", "Info", and "Sensor", the values can neither be entered nor changed.

#### Name

In this menu, the identification name of the centrifuge will be defined.

- The characters can be entered when the cursor flashes in the text field. Turn the function knob in order to select a character and press it to confirm the selection. Then, press the knob again in order to enter the next character. Pressing the arrow button ← will delete the last character. The maximum number of characters is 19.
- When the name is complete, select the option "Accept" and confirm it.

#### **Buzzer**

In this menu, an acoustic/optical signal can be selected for

- the end of a centrifugation run
- an imbalance message
- an error message.

The duration of the buzzer signal can be specified.

#### **External**

This function is only available if the centrifuge is equipped with the option for the input and output of data (external signal, floating switch) (see chapter 6.3.3.5 - "**Options for data input and output**").

### 6.3.2.8 Curve menu

In this menu, free acceleration and deceleration curves can be created and edited in compliance with certain restrictions (see chapter 11.3 - "Acceleration and deceleration curves").

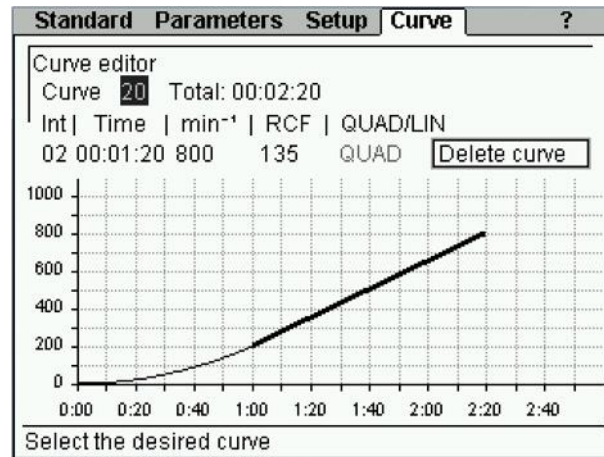

Fig. 24: Curve menu

#### Creating and editing an acceleration curve



#### NOTE

During a centrifugation run, curves can only be used for displaying purposes. It is not possible to edit or delete them.

- Select the "Curve" menu. The curve editor will be displayed.
- Select a curve number between 20 and 29 under "Curve". If the selected curve number is already used, the saved curve will be displayed.
- Define the interval number of the process under "Int". For every curve, up to ten intervals can be entered.
- Enter the interval time under "Time", but take the restrictions into consideration (see below).
- Enter the desired acceleration under "RPM" or "RCF", but take the restrictions into consideration (see below). The values are interdependent
- For the first interval, a linear or quadratic rise can be selected under "QUAD/LIN". All of the other intervals are linear.

The field "Total" shows the total runtime of the process. The maximum runtime of a curve is dependent on the slope of the curve and on the final speed of the rotor.



#### NOTE

Only the last curve interval can be edited.

## 6 Using the centrifuge

### Restrictions

- Deceleration and acceleration curves may include intervals with a positive slope as well as with a zero slope.
- The slope of the curve intervals may be between 1 rpm/sec and 1000 rpm/sec maximum.
- Square curve intervals are only possible between 0 and 1000 rpm max. If the selected final speed is higher than 1000 rpm, this interval will automatically turn into a linear one above 1000 rpm.
- The possible runtime depends on the maximum possible speed (depending on the rotor) and the slope limitation.

Example 1: Start speed 0 rpm, final speed 100 rpm, a runtime of 1 hour is not possible since the required slope is  $< 0.03$  rpm and, therefore, is outside of the defined range.

Example 2: Start speed 0 rpm, final speed 15000 rpm, a runtime of 10 seconds is not possible since the required slope is 1500 rpm and, therefore, is outside of the defined range.

### 6.3.2.9 Help menu

The help menu provides short descriptions of the control elements of the selected option.

#### Activating/deactivating the help function

- Select the question mark in the menu bar and press the function knob.
- Quit the help function by selecting the question mark and by pressing the function knob again.

Parameters can be changed when the help function is activated.

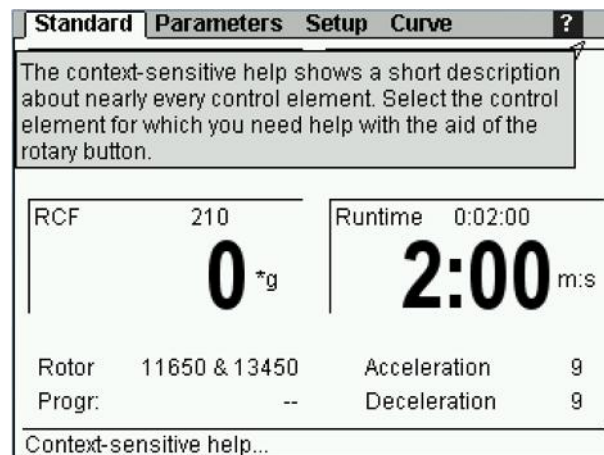

Fig. 25: Help menu

### 6.3.2.10 Changing the contrast

To change the contrast:

- Press and hold the stop key and turn the function knob one notch to the left. A dialog box will be displayed once the stop key is released.
- Adjust the contrast of the centrifuge display and confirm the change.

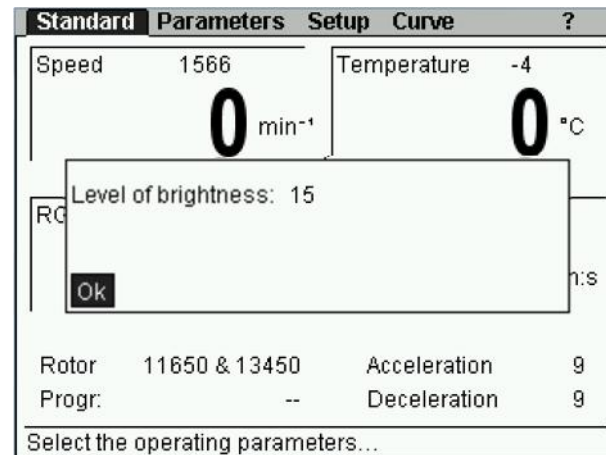

Fig. 26: Dialog box for changing the contrast

### 6.3.3 Program mode

A program contains all the data that are required for a centrifuge run. Certain sedimentation results can be repeated under identical conditions. Programs can be loaded, executed, edited, and deleted when the centrifuge is at a standstill.

A maximum of 60 programs can be stored under the numbers 1 - 60. The rapid cooling program "RAPID\_TEMP" does not occupy any storage location and cannot be deleted. It is used to cool the centrifuge without vessels.

"--" means that the values that are currently set are not a stored program. The programs can be protected against unauthorised use, modification, or deletion with the aid of a code (see chapter 6.3.2.6 - "**Parameters menu**").

#### 6.3.3.1 Loading a program

- Select the option "Progr" from the "Standard" menu and confirm the selection. The program selection list will be displayed.
- Select the desired program from the list and confirm the selection by pressing the function knob.

The program is now loaded.

## 6 Using the centrifuge

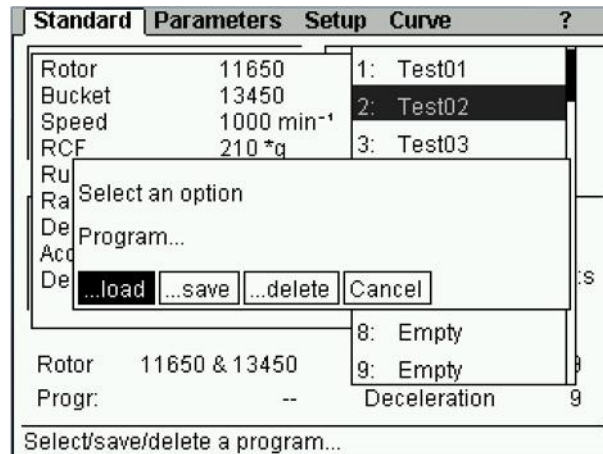

Fig. 27: Loading a program

### 6.3.3.2 Saving a program

- Enter the parameters that are to be included in the program.
- Select the option "Progr" and confirm the selection. The program selection list will be displayed.
- Select a storage location from the program selection list.
- Save the program under the desired name. The characters can be entered when the cursor flashes in the text field. The maximum number of characters is 19.
  - Turn the function knob in order to select a character and press it to confirm the selection.
  - Then, press the knob again in order to enter the next character.
  - Pressing the arrow button ← will delete the last character.
- When the program name is complete, select the option "OK" and confirm it.

The program is now saved.

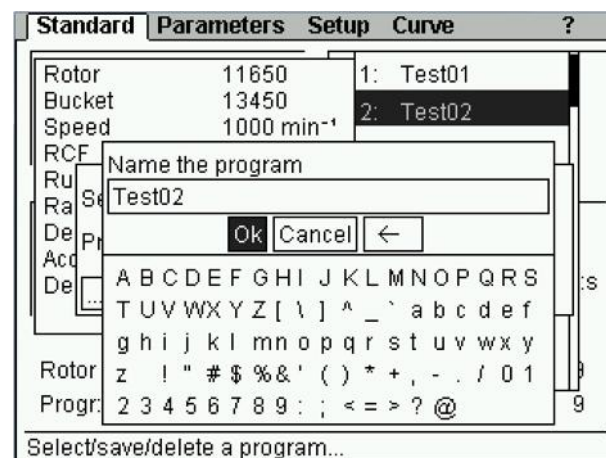

Fig. 28: Entering the program name before saving

### 6.3.3.3 Deleting a program

- Select the option "Progr" and confirm the selection. The program selection list will be displayed.
- Select the desired program.
- Select the option "Delete" and confirm it.

The program is now deleted.

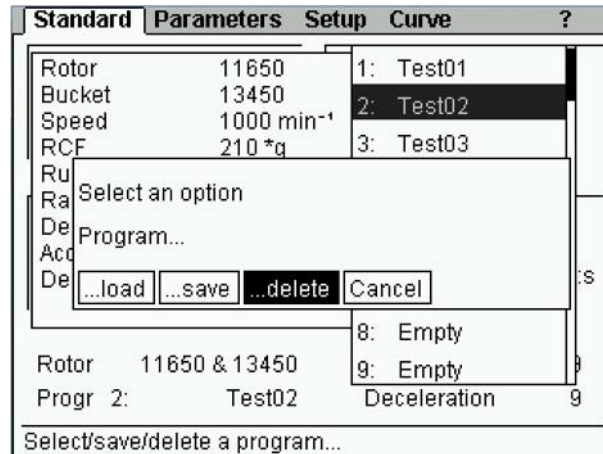

Fig. 29: Deleting a program

### 6.3.3.4 Automatic program rotation

With the program rotation, programs can be executed directly one after another.

- Select "Program rotation" in the "Setup" menu.

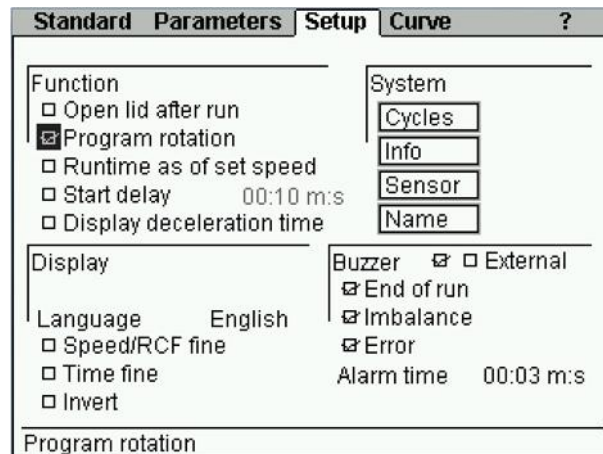

Fig. 30: Program rotation function

The current program is loaded and can be started. After the end of the run, the next program will be loaded automatically. The rotation ends with the first empty location and restarts from the beginning:

**Example 1:** Loading of Test1  
Rotation: Test1, Test2, Test3, Test1,...

**Example 2:** Loading of Test2  
Rotation: Test2, Test3, Test2,...



## 6 Using the centrifuge

While the program rotation is active, an arrow is displayed in the program field of the standard menu (see figure below).

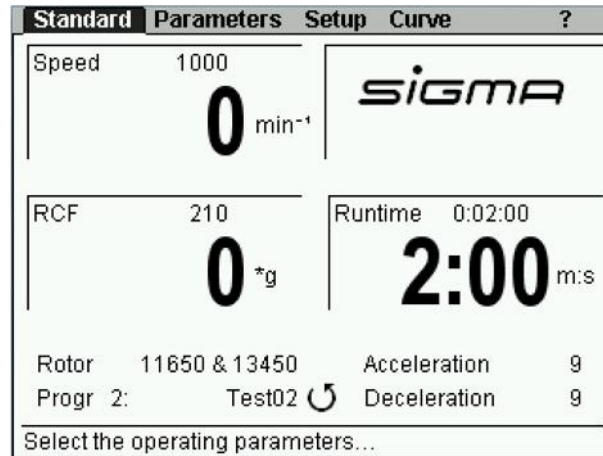

Fig. 31: Automatic program rotation

### 6.3.3.5 Options for data input and output

- Connection for a serial interface (depending on the centrifuge type, partially standard).
- External signal active DC 24V, 0.5A max. (part no. 17701)
- Floating switch AC 250V max. 6A (part no. 17702)

## 6.4 Switching the centrifuge off

- Open the centrifuge when it is not in use so moisture can evaporate.
- Switch the centrifuge off by pressing the mains power switch.



## 7 Malfunctions and error correction

### 7.1 General malfunctions

Malfunctions are indicated by a dialog box. If the acoustic signal is activated, it sounds when the error message is displayed.

- Eliminate the source of the problem (see table below).
- Acknowledge the error messages by pressing the lid key.



**NOTE**

Error messages can be eliminated by pressing the lid key. The error itself will not be eliminated, but the centrifuge can be operated again.

Type of error	Possible reason	Correction
No indication on the display	No power in the mains supply	Check fuse in the mains supply
	Power cord is not plugged in	Plug in power cord correctly
	Fuses have tripped	Reactivate temperature fuse (see chapter 5.3.1 - " <b>Connection</b> ")
	Mains power switch off	Switch mains power switch on
Centrifuge cannot be started: start key LED is not illuminated	Several	Power off/on. If the error occurs again, contact service
Centrifuge cannot be started: lid key LED flashes	The lid lock is not closed correctly	Open and close the lid. If the error occurs again, contact service
Centrifuge decelerates during operation	Brief mains power failure	Press start key in order to restart the centrifuge
	System error	Power off/on. If the error occurs again, contact service
Centrifuge decelerates during operation, imbalance dialog box is displayed	– Improper loading – Centrifuge is inclined – Drive problem – Centrifuge was moved during run	Balance load and restart the centrifuge. If the error occurs again, contact service(see chapter 7.1.1 - " <b>Emergency lid release</b> ")
	– Ungreased load- bearing bolts	Clean and grease load- bearing bolts
Lid cannot be opened	Lid lock has not released	
	Lid seal sticks	Clean the lid seal and apply talcum powder
Temperature value cannot be reached (only for refrigerated centrifuges)	Condenser dirty (only air-cooled units)	Clean the condenser. If the error occurs again, contact service

## 7 Malfunctions and error correction

### 7.1.1 Emergency lid release

In the event of a power failure, it is possible to manually open the centrifuge lid.

- Switch off the mains power switch and disconnect the power cord from the socket.
- Remove the plugs (see figure, item 1) at the right side panel, e.g. with a screw driver.



Fig. 32: Position of the openings for the emergency lid release

- Insert the supplied tube wrench (part no. 930 110) horizontally into the hole. The key will be guided through a funnel-shaped tube to the shaft of the lid lock motor.



Fig. 33: The emergency lid release key must be inserted horizontally.

- Unlock the motorized lid locks by turning it clockwise.
- Then, reinsert the plugs.



**WARNING**

The lid may only be unlocked and opened when the rotor is at a standstill.

If the lid is opened with the emergency lid release during operation, the centrifuge will be switched off immediately and decelerate without brake.

## 7.2 Table of error codes

Error no.	Kind of error	Measures	Note
1-9	System error	<ul style="list-style-type: none"> <li>Allow to slow down</li> <li>Power off/on</li> </ul>	All these errors stop the centrifuge or cause it to decelerate brakeless
10-19	Speedometer error	<ul style="list-style-type: none"> <li>Allow to slow down</li> <li>Power off/on</li> </ul>	
20-29	Motor error	<ul style="list-style-type: none"> <li>Power off</li> <li>Ensure ventilation</li> </ul>	
30-39	EEPROM error	<ul style="list-style-type: none"> <li>Allow to slow down</li> <li>Power off/on</li> </ul>	With error 34, 35, and 36, the centrifuge will stop; with error 37 and 38 only an error message will be given
40-45	Temperature error (only for refrigerated centrifuges)	<ul style="list-style-type: none"> <li>Allow to slow down</li> <li>Power off</li> <li>Allow to cool down</li> <li>Provide better ventilation (only air cooled centrifuges)</li> <li>Provide sufficient water throughput (only water cooled centrifuges)</li> </ul>	
46-49	Imbalance error	<ul style="list-style-type: none"> <li>Allow to slow down</li> <li>Power off</li> <li>Eliminate the imbalance</li> </ul>	
50-59	Lid error	<ul style="list-style-type: none"> <li>Press lid key</li> <li>Close lid</li> <li>Remove foreign matter from the opening of the lid lock device</li> </ul>	With error 50 and 51, the centrifuge will stop
60-69	Process error	<ul style="list-style-type: none"> <li>Allow to slow down</li> <li>Power off/on</li> </ul>	With error 60 message "power failure during run", with error 61, the message "stop after power on"
70-79	Communication error	<ul style="list-style-type: none"> <li>Allow to slow down</li> <li>Power off/on</li> </ul>	
80-89	Parameter error	<ul style="list-style-type: none"> <li>Power off</li> <li>Allow to cool down</li> <li>Provide for better ventilation</li> </ul>	With error 83, error message only
90-99	Other errors	<ul style="list-style-type: none"> <li>Check connections</li> <li>Provide sufficient water throughput (only water cooled centrifuges)</li> </ul>	



**NOTE**

If it is impossible to eliminate the errors, contact the service!

### 7.3 Service contact

In the event of queries, malfunctions, or spare part enquiries:

**From Germany:**

- Use the service request form at [www.sigma-zentrifugen.de](http://www.sigma-zentrifugen.de) → [Service Area]
- or contact

Sigma Laborzentrifugen GmbH  
An der Unteren Söse 50  
37520 Osterode (Germany)  
Tel. +49 (0) 55 22 / 50 07-84 25  
Fax +49 (0) 55 22 / 50 07-94 25  
E-mail: [service@sigma-zentrifugen.de](mailto:service@sigma-zentrifugen.de)

**Outside Germany:**

Contact our agency in your country. All agencies are listed at [www.sigma-zentrifugen.de](http://www.sigma-zentrifugen.de) → [Contacts] → [Foreign agencies]



**NOTE**

- If you would like to utilise our service, please state the type of your centrifuge and its serial number.
- Please use the request on our website (see above).

## 8 Maintenance and service

The centrifuge, rotor, and accessories are subject to high mechanical stress. Thorough maintenance performed by the user extends the service life and prevents premature failure.



### CAUTION

If corrosion or other damage occurs due to improper care, the manufacturer cannot be held liable or subject to any warranty claims.

- Use soap water or other water-soluble, mild cleaning agents with a pH value between 6 and 8 for cleaning the centrifuge and accessories.
- Avoid corrosive and aggressive substances.
- Do not use solvents.
- Do not use agents with abrasive particles.
- Do not expose the centrifuge and rotors to intensive UV radiation or thermal stress (e.g. by heat generators).

### 8.1 Maintenance

#### 8.1.1 Centrifuge

- Unplug the mains power plug before cleaning.
- Carefully remove all liquids, including water and particularly all the solvents, acids, and alkaline solutions from the rotor chamber using a cloth in order to avoid damage to the motor bearings.
- If the centrifuge has been contaminated with toxic, radioactive, or pathogenic substances, clean the rotor chamber immediately with a suitable decontamination agent (depending on the type of contamination).



### WARNING

Take suitable precautions for your own safety if there is a risk of toxic, radioactive, or pathogenic contamination.

- Grease the motor shaft slightly after cleaning (grease for load-bearing bolts part no. 70284).

## 8 Maintenance and service

### 8.1.2 Condenser (only air-cooled centrifuges)

In order to cool the refrigerant that is compressed by the refrigeration unit, a lamellar condenser is used. It is cooled by air.

Dust and dirt obstruct the cooling flow of air. The dust on condenser pipes and lamellas reduces the heat exchange and thus the performance of the refrigeration unit.

This is why the installation site should be as clean as possible.

- Check the condenser at least once a month for dirt and clean it if necessary.
- If you have any queries, please contact service (see chapter 7.3 - "Service contact").

### 8.1.3 Accessories



**CAUTION**

For the care of the accessories, special safety measures must be considered as these are measures that will ensure operational safety at the same time!



**WARNING**

All swing-out rotors applicable for this centrifuge and the angle rotor 12510 weigh more than 18 kg.

- Always lift the rotors with a lifting device or with a sufficient number of people helping you.
- Immediately rinse off the rotor, buckets, or accessories under running water if they have come into contact with any liquids that may cause corrosion. Use a brush for test tubes to clean the bores of angle rotors. Turn the rotor upside down and allow it to dry completely.
- Clean the accessories outside the centrifuge once a week or preferably after each use. Adapters should be removed, cleaned and dried.



**CAUTION**

#### **Do not clean the accessories in a dishwasher!**

Cleaning in a dishwasher removes the anodised coating; the result is cracking in areas that are subject to stress.

- If the rotors or accessories have been contaminated with toxic, radioactive, or pathogenic substances, clean them immediately with a suitable decontamination agent (depending on the type of contamination). Take suitable precautions for your own safety if there is a risk of toxic, radioactive, or pathogenic contamination.
- Dry the accessories with a soft cloth or in a drying chamber at approx. 50°C.



#### **8.1.3.1 Plastic accessories**

The chemical resistance of plastic decreases with rising temperatures (see chapter 11.5 - "**Resistance data**").

- If solvents, acids, or alkaline solutions have been used, clean the plastic accessories thoroughly.

#### **8.1.4 Rotors, buckets and carriers**

Rotors, buckets and carriers are produced with the highest precision, in order to withstand the permanent high stress from high gravitational fields.

Chemical reactions as well as stress-corrosion (combination of oscillating pressure and chemical reaction) can affect or destroy the metals. Barely detectable cracks on the surface can expand and weaken the material without any visible signs.

- Check the material regularly (at least once a month) for
  - cracks
  - visible damage of the surface
  - pressure marks
  - signs of corrosion
  - other changes.
- Check the bores of the rotors and multiple carriers.
- Replace any damaged components immediately for your own safety.
- Grease the rotor tie-down screw after cleaning with grease for load bearing bolts (part no. 70284) and spread the grease with a cloth.

#### **8.1.5 Load bearing bolts**

Only greased load bearing bolts ensure the even swinging of the buckets and, therefore, the quiet run of the centrifuge. Non-greased bolts can lead to a system shut-down due to imbalances.

Apply a small quantity of grease (part no. 70284) to the load bearing bolts of the rotor and buckets after each cleaning.

## 8 Maintenance and service

### 8.1.6 Glass breakage



#### CAUTION

In the case of glass breakage, immediately remove all glass particles (e.g. with a vacuum cleaner). Replace the rubber cushions since even thorough cleaning will not remove all glass particles.

Glass particles will damage the surface coating (e.g. anodising) of the buckets, which will then lead to corrosion.

Glass particles in the rubber cushions of the buckets will cause glass breakage again.

Glass particles on the pivot bearing of the load-bearing bolts prevent the buckets and carriers from swinging evenly, which will cause an imbalance.

Glass particles in the rotor chamber will cause metal abrasion due to the strong air circulation. This metal dust will not only pollute the rotor chamber, rotor, and materials to be centrifuged but also damage the surfaces of the accessories, rotors, and rotor chamber.

#### **In order to completely remove the glass particles and metal dust from the rotor chamber:**

- Grease the upper third of the rotor chamber with e.g. Vaseline.
- Then, let the rotor rotate for a few minutes at a moderate speed (approx. 2000 rpm). The glass and metal particles will now collect at the greased part.
- Remove the grease with the glass and metal particles with a cloth.
- If necessary, repeat this procedure.

## 8.2 Sterilisation and disinfection of the rotor chamber and accessories

- Use commercially-available disinfectants such as, for example, Sagrotan<sup>®</sup>, Buraton<sup>®</sup>, or Terralin<sup>®</sup> (available at chemist's shops or drugstores).
- The centrifuge and the accessories consist of various materials. A possible incompatibility must be considered.
- Before using cleaning or decontamination agents that were not recommended by us, contact the manufacturer to ensure that such a procedure will not damage the centrifuge.
- For autoclaving, consider the continuous heat resistance of the individual materials (see chapter 8.2.1 - "**Autoclaving**").

Please contact us if you have any queries (see chapter 7.3 - "**Service contact**").



#### DANGER

If dangerous materials (e.g. infectious and pathogenic substances) are used, the centrifuge and accessories must be disinfected.



### 8.2.1 Autoclaving

The service life of the accessories essentially depends on the frequency of autoclaving and use.

- Replace the accessories immediately when the parts show changes in colour or structure or in the occurrence of leaks etc.
- During autoclaving, the caps of the tubes must not be screwed on in order to avoid the deformation of the tubes.



**NOTE**

It cannot be excluded that plastic parts, e.g. lids or carriers, may deform during autoclaving.

Accessories	Max. temp. (°C)	Min. time (min)	Max. time (min)	Max. cycles
Aluminium buckets	134-138	3	5	-
Aluminium rotors	134-138	3	5	-
Glass tubes	134-138	3	40	-
Polyallomer / polycarbonate rectangular carriers	115-118	30	40	-
Polyallomer / polycarbonate round carriers	115-118	30	40	-
Polycarbonate / polyallomer lids for angle rotors	115-118	30	40	20
Polycarbonate tubes	115-118	30	40	20
Polypropylene balance adapter for blood-bag systems	115-118	30	40	n.s.
Polypropylene copolymer tubes	115-121	30	40	20
Polypropylene rectangular carriers	115-118	30	40	-
Polypropylene rotors	115-118	30	40	20
Polypropylene round carriers	115-118	30	40	-
Polysulfone caps for buckets	134-138	3	5	100
Polysulfone lids for angle rotors	134-138	3	5	100
Rubber adapters	115-118	30	40	-
Stainless-steel balance weight for blood-bag systems	121	30	30	n.s.
Teflon tubes	134-138	3	5	100

### 8.3 Service

**DANGER**

In the event of service work that requires the removal of the panels, there is a risk of electric shock or mechanical injury. Only qualified specialist personnel is authorised to perform this service work.

The centrifuge is subject to high mechanical stress. In order to be able to withstand this high level of stress, high-quality components were used during the production of the centrifuge. Nevertheless, wear cannot be excluded and it may not be visible from the outside. Especially the rubber parts that are – among other things – part of the motor suspension, are subject to ageing.

This is why we recommend having the centrifuge checked by the manufacturer during an inspection once per year in the operating state and once every three years in the dismantled state. Rubber parts should be replaced after three years.

Information and appointments:

**In Germany:**

- Use the service request form at [www.sigma-zentrifugen.de](http://www.sigma-zentrifugen.de) → [Service Area]
- or contact

Sigma Laborzentrifugen GmbH  
An der Unteren Söse 50  
37520 Osterode (Germany)  
Tel. +49 (0) 55 22 / 50 07-84 25  
Fax +49 (0) 55 22 / 50 07-94 25  
E-mail: [service@sigma-zentrifugen.de](mailto:service@sigma-zentrifugen.de)

**Outside Germany:**

Contact our agency in your country. All agencies are listed at [www.sigma-zentrifugen.de](http://www.sigma-zentrifugen.de) → [Contacts] → [Foreign agencies]

**NOTE**

- If you would like to utilise our service, please state the type of your centrifuge and its serial number.
- Please use the request form on our website (see above).

## 8.4 Return of defective parts

Although we exercise great care during the production of our products, it may be necessary to return a unit or accessory to the manufacturer.

In order to ensure the quick and economical processing of returns of centrifuges, spare parts, or accessories, we require complete and extensive information concerning the process. Please fill in the following forms completely, sign them, enclose them with the return package, and send them together with the product to:

Sigma Laborzentrifugen GmbH  
An der Unteren Söse 50  
37520 Osterode (Germany)

### 1. Declaration of decontamination

As a certified company and due to the legal regulations for the protection of our employees and of the environment, we are obliged to certify the harmlessness of all incoming goods. For this purpose, we require a declaration of decontamination.

- The form must be filled in completely and signed by authorised and specialised personnel only.
- Affix the original form in a clearly visible manner to the outside of the packaging.



If no such declaration is enclosed in the return package, we will perform the decontamination at your expense!

### 2. Form for the return of defective parts

This form is for the product-related data. They facilitate the assignment, and they enable the quick processing of the return. If several parts are returned together in one packaging, please enclose a separate problem description for every defective part.

- A detailed problem description is necessary in order to perform the repair quickly and economically.



If the form does not include a description of the malfunction, neither a refund nor a credit note can be issued. In this case, we reserve the right to return the parts to you at your expense.

- Please note on the form if you would like to receive a cost estimate. Cost estimates are only prepared upon request and against charge. If an order is placed, these charges will be offset.



The unit must be packaged in a transport-safe manner. Please use the original packaging, if at all possible.

If the product is dispatched to us in unsuitable packaging, you will be charged the cost for returning it to you in new packaging.

The forms can be downloaded online from  
[www.sigma-zentrifugen.de](http://www.sigma-zentrifugen.de) → [Service Area].

## 9 Disposal

### 9.1 Disposal of the centrifuge



In accordance with the directive 2002/96/EC, SIGMA centrifuges are marked with the symbol shown to the left. This symbol means that it is not permissible to dispose of the unit among household waste.

- You can return these centrifuges free of cost to Sigma Laborzentrifugen GmbH.
- Ensure that the unit is decontaminated. Fill in a declaration of decontamination (see chapter 8.4 - "**Return of defective parts**").
- Comply with any other applicable local rules and regulations.

### 9.2 Disposal of the packaging

- Use the packaging to return the centrifuge for disposal or
- dispose of the packaging, after having separated the individual materials.
- Comply with all local rules and regulations.

## 10 Technical data

<b>Manufacturer</b>		<b>SIGMA Laborzentrifugen GmbH An der Unteren Söse 50 37520 Osterode (Germany)</b>	
Type:	8KS	8KBS	
<u>Connection requirements</u>			
Electr. connection:	see name plate	see name plate	
Protection class:	I	I	
IP code:	20	20	
Connected load (kVA):	7.5	7.5	
Power consumption (kW):	6.5	6.5	
Max. current consumption (A):	11.5 (at 3x400V / 50 Hz)	11.5 (at 3x400V / 50 Hz)	
Input fuse:	16.0	16.0	
<u>Performance data</u>			
Max. speed (rpm):	10,500	5,100	
Max. capacity (ml):	12,000	12,000	
Max. gravitational field (x g):	20,954	8,578	
Max. kin. energy (Nm):	275,321	275,321	
<u>Other parameters</u>			
Time range:	10 sec to 99 h 59 min 59 sec,	10 sec to 99 h 59 min 59 sec	
Temperature range:	short run, continuous run	short run, continuous run	
Storage locations:	-20 to +40°C	-20 to +40°C	
	60	60	
<u>Physical data</u>			
Height (mm):	980	980	
Height with open lid (mm):	1,690	1,690	
Width (mm):	810	810	
Depth (mm):	910	910	
Weight (kg):	420	420	
EMC as per EN 61326:	Class B	Class B	
Noise level (dBA):	< 73 (at maximum speed)	< 73 (at maximum speed)	
<u>Special equipment:</u>			
<u>Water cooling system</u>			
Tap connections (inch):	2 x ¾	2 x ¾	
Inlet pressure (bar):	1.5 to 5.0	1.5 to 5.0	
Max. flow rate (m <sup>3</sup> /h):	0.5	0.5	
Max. temperature at water inlet (°C):	20	20	

## 10 Technical data

---

### 10.1 Ambient conditions

- The figures are valid for an ambient temperature of  $+23^{\circ}\text{C} \pm 2^{\circ}\text{C}$  and a nominal voltage  $\pm 10\%$ . The minimum temperature is  $< +4^{\circ}\text{C}$  and depends on the rotor type, speed, and ambient temperature.



#### NOTE

At a nominal voltage of 100V or 200V, a tolerance of  $+10\%$  /  $-5\%$  applies.

- For indoor use only.
- Allowable ambient temperature  $+5^{\circ}\text{C}$  to  $+35^{\circ}\text{C}$ .
- Max. relative humidity of air 80% up to  $31^{\circ}\text{C}$  with a linear decrease to 67% relative humidity of air at  $35^{\circ}\text{C}$ .
- Maximum altitude 2,000 m above sea level.

### 10.2 Technical documentation

For environmental reasons, the comprehensive technical documentation of the centrifuge (e.g. circuit diagrams) and the safety data sheets of the manufacturers of refrigerant and lubricants are not attached to this documentation.

You can order these documents at [www.sigma-zentrifugen.de](http://www.sigma-zentrifugen.de) by way of our "service request" form.

## 11 Appendix

### 11.1 Range of accessories

Part no.	Description	Max. speed (rpm)	Max. gravitational field (x g)
11805	Swing-out rotor with wind shield, 6 place, for buckets no. 13845 <sup>2</sup> , max. radius 25.0 cm, min. radius 14.0 cm	5 100	7 328
	13850, max. radius 29.5 cm, min. radius 17.0 cm	5 100	8 578
	13860, max. radius 28.7 cm, min. radius 14.5 cm	4 100	5 394
	<b>Only use the rotor with closed wind shield!</b>		
11806	Swing-out rotor, 6 place, for buckets no. 13845 <sup>3</sup> , max. radius 25.0 cm, min. radius 14.0 cm	3 700	3 857
	13850, max. radius 39.5 cm, min. radius 17.0 cm	3 700	4 515
	13855, max. radius 29.4 cm, min. radius 14.2 cm	3 300	3 579
	13860, max. radius 28.7 cm, min. radius 14.5 cm	3 700	4 393
12505-H <sup>4</sup>	Angle rotor 6 x 500 ml, for bottles no. 13507, 15508 and adapters 14144 - 14155, sealable with hermetic aluminium lid no. 17891, Radius max. 16.6 cm, radius min. 4.1 cm, angle 30°	10 500	20 461
12510-H <sup>5</sup>	Angle rotor 6 x 1000 ml, incl. steel buckets no. 13511, for bottles no. 13510, 15921 and adapters 14162 - 14182, sealable with hermetic aluminium lid no. 17892 Radius max. 20.6 cm, radius min. 5.5 cm, angle 25°	7 000	11 285
13845 <sup>6</sup>	Bucket for microtiter plates, incl. plate holder no. 17981 and cap 17108, max. height of plates approx. 105 mm, 1 set = 2 pcs.		
13850	Round bucket, sealable with cap no. 17175, for adapters Ø 115 mm, no. 17775, 17777, 17780, adapters no. 13851, 13852 and bottles no. 13840, 15930, 15932 without 17175, 1 set = 2 pcs.		
13855	Double bucket 2 x 1000 ml, for tubes no. 13510, 15920 and 15921 with 13511, for adapters Ø 100 mm, no. 17650 - 17699, 1 set = 2 pcs.		

#### Accessories for blood bags

Part no.	Description	Max. speed (rpm)	Max. gravitational field (x g)
13860	Double bucket 2 x 300 – 900 ml, incl. adapter no. 13865 for 2 blood bag systems, incl. 2 sets balance weights 5 g no. 17751 and 1 set balance weights 10 g no. 17752, 1 set = 2 pcs.		
13865	Adapter for 2 blood bags 500 - 800 ml incl. 2 sets balance weights 5 g no. 17751 and 1 set balance weights 10 g no. 17752, 1 set = 2 pcs., service life max. 1.000 cycles		

<sup>2</sup> Not for Sigma 8KBS

<sup>3</sup> Not for Sigma 8KBS

<sup>4</sup> Not for Sigma 8KBS incl. accessories

<sup>5</sup> Not for Sigma 8KBS incl. accessories

<sup>6</sup> Not for Sigma 8KBS

## 11 Appendix

Part no.	Description	Max. speed (rpm)	Max. gravitational field (x g)
13866	Adapter for 2 blood bags 900 ml, 1 set = 2 pcs., service life max. 1.000 cycles		
17751	Balance weight 5 g, suitable in 13865, 13866, 1 set = 2 pcs.		
17752	Balance weight 10 g, suitable in 13865, 13866, 1 set = 2 pcs.		
17753	Balance weight 50 g, suitable in 17765, 17766, 1 set = 2 pcs.		
17754	Balance weight 50 g, suitable in 17765, 17766, 1 set = 2 pcs.		
17765	Balance adapter, replacement for one blood bag, 450 g, suitable in 13865, 1 set = 2 pcs.		
17766	Balance adapter, replacement for one blood bag, 600 g, suitable in 13866, 1 set = 2 pcs.		

### Adapters and stainless steel tubes

Part no.	Description
13055	Stainless steel tube 50 ml, Ø 28.5 x 101.5 mm, sealable with cap no. 17054
13085	Stainless steel tube 85 ml, Ø 38 x 103 mm, sealable with cap no. 17185
13255	Stainless steel bottle 250 ml, Ø 61.4 x 125 mm, sealable with cap no. 17256
13507	Stainless steel tube 500 ml, Ø 69,5 x 152 mm, sealable with cap no. 17256
13510	Stainless steel bottle 1000 ml, Ø 100 x 167 mm, incl. cap no. 17520
13511	Stainless steel tube Ø 100 x 152 mm, for tubes no. 15920, 15921, use without cap in rotor 12510-H
13840	Stainless steel tube 1500 ml, Ø 115 x 165 mm, 1300 ml without cap
13851	Adapter for stainless steel bottle 1000 ml, no. 13510, adapters Ø 100 mm, no. 17650 - 17699, 1 set = 2 pcs.
13852	Adapter for 1000 ml bottles Ø 98 mm no. 15920, 15921, 1 set = 2 pcs.

The complete list of accessories can be downloaded from [www.sigma-zentrifugen.de](http://www.sigma-zentrifugen.de).



### 11.1.1 Maximum speed for tubes

Some tubes, such as centrifuge glass tubes, microtubes, culture tubes, fluoropolymer tubes and especially high-volume tubes can be used in our rotors, buckets, and adapters at higher speeds than their breaking limit.

- Always fill the tubes up to their useful volume (= the volume that is stated for the tube).
- When installing the 500 ml bottles use the supplied supporting rings.



**CAUTION**

At speeds above 8,000 rpm, there is an increased risk of breakage, in particular for 250 and 500 ml bottles!

### 11.1.2 Rotor radii

The information in the accessories table concerning the radius refers to the values of the respective rotor as shown below. The radius calculation is described in (see chapter 2.2.2.1 - "**Speed, radius, and relative centrifugal force**").

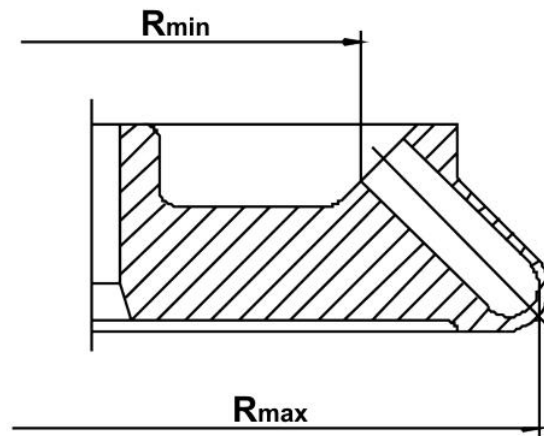

Fig. 34: Minimum and maximum radius of an angle rotor

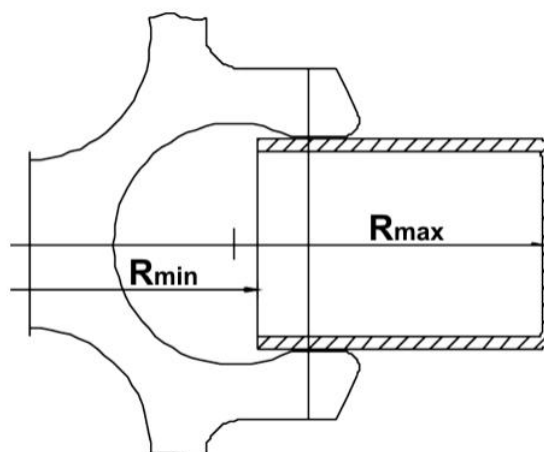

Fig. 35: Minimum and maximum radius of a swing-out rotor

## 11.2 Speed-gravitational-field-diagram

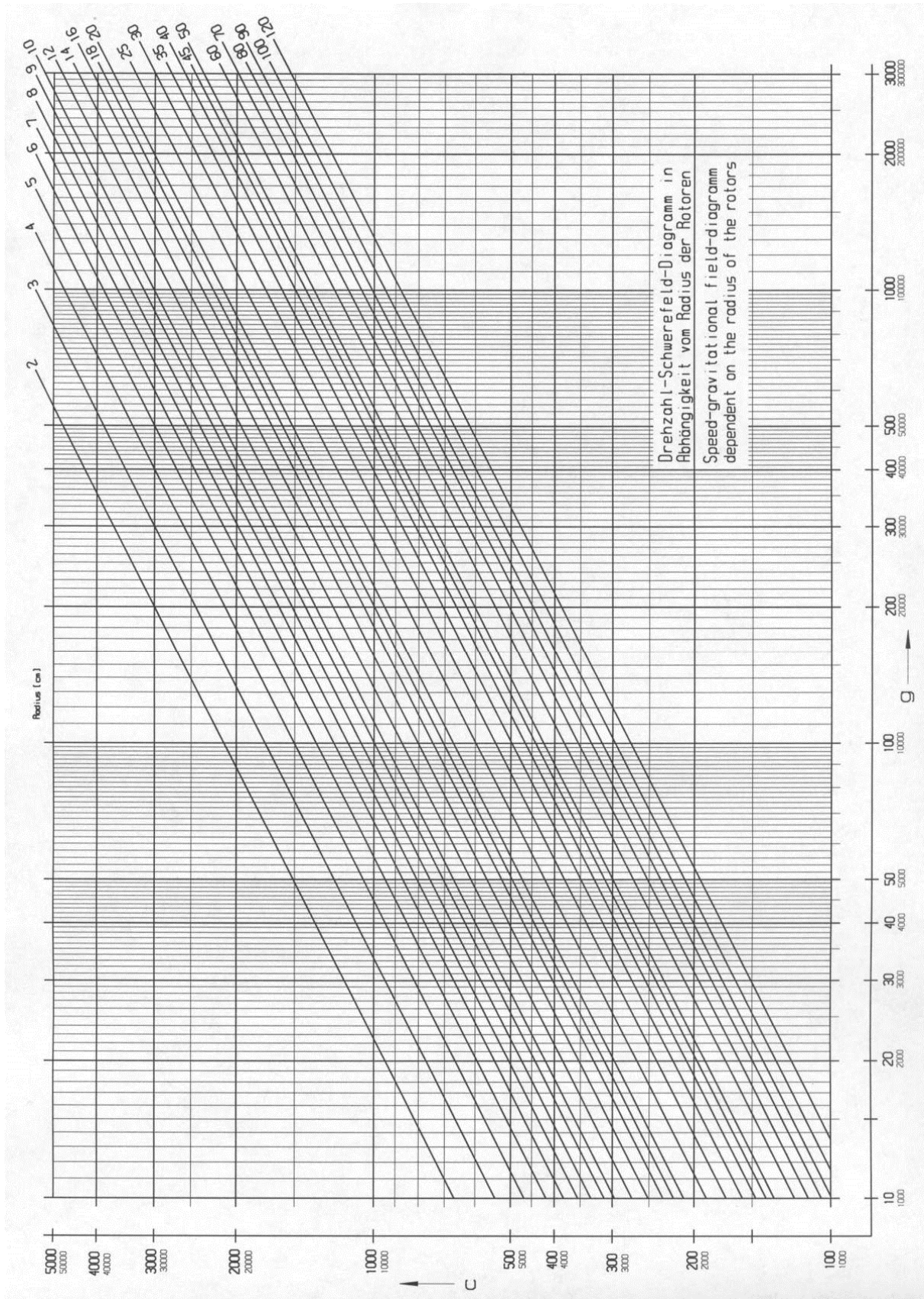

Fig. 36: Speed-gravitational-field-diagram

### 11.3 Acceleration and deceleration curves

Linear as well as quadratic curves are numbered in the direction of increasing acceleration (from right to left).

The deceleration curves are inverted images of the acceleration curves and are assigned the same numbers. An exception is curve 0. It decelerates brakeless (spin-out).

In general, the runtime, until the set speed is reached, depends on the moment of inertia of the rotor.

#### Linear curves

The slope of the fixed acceleration curves defines the time that is required to accelerate the rotor by 1,000 rpm.

Curve 9 is a special case compared to the other curves. The centrifuge accelerates with maximum power. The runtime, until the set speed is reached, depends solely on the moment of inertia of the rotor.

Linear curve no.	Slop
0	4 [rpm/sec]
1	6 [rpm/sec]
2	8 [rpm/sec]
3	17 [rpm/sec]
4	25 [rpm/sec]
5	33 [rpm/sec]
6	50 [rpm/sec]
7	100 [rpm/sec]
8	200 [rpm/sec]
9	1.000 [rpm/sec]

Fig. 37: Slope of linear curves

#### Quadratic curves

Curve 19 is a special case compared to the other curves. The centrifuge accelerates with maximum power. The runtime depends solely on the moment of inertia of the rotor.

Quadratic curve no.	Time until 1,000 rpm	Slope as of 1,000 rpm
10	500 sec	4 [rpm/sec]
11	333 sec	6 [rpm/sec]
12	250 sec	8 [rpm/sec]
13	118 sec	17 [rpm/sec]
14	80 sec	25 [rpm/sec]
15	60 sec	33 [rpm/sec]
16	40 sec	50 [rpm/sec]
17	20 sec	100 [rpm/sec]
18	10 sec	200 [rpm/sec]
19	2 sec	1.000 [rpm/sec]

Fig. 38: Slope of quadratic curves

11 Appendix

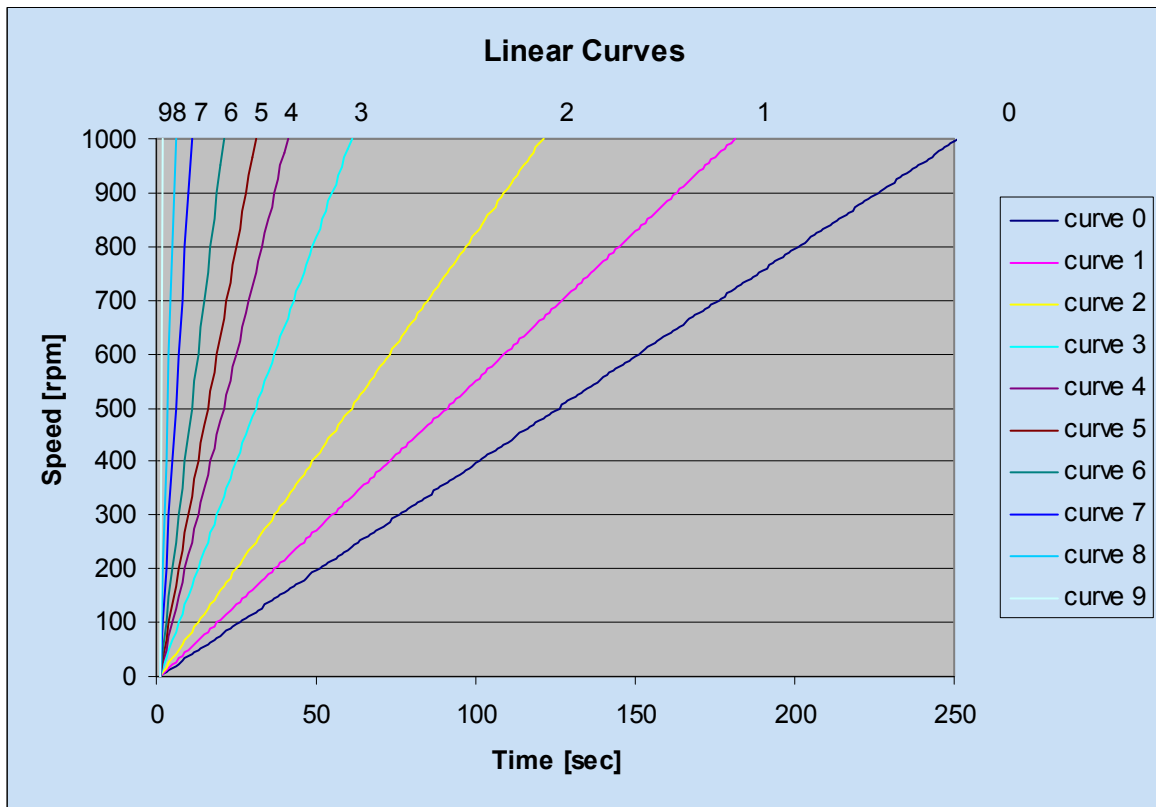

Fig. 39: Diagram of linear curves

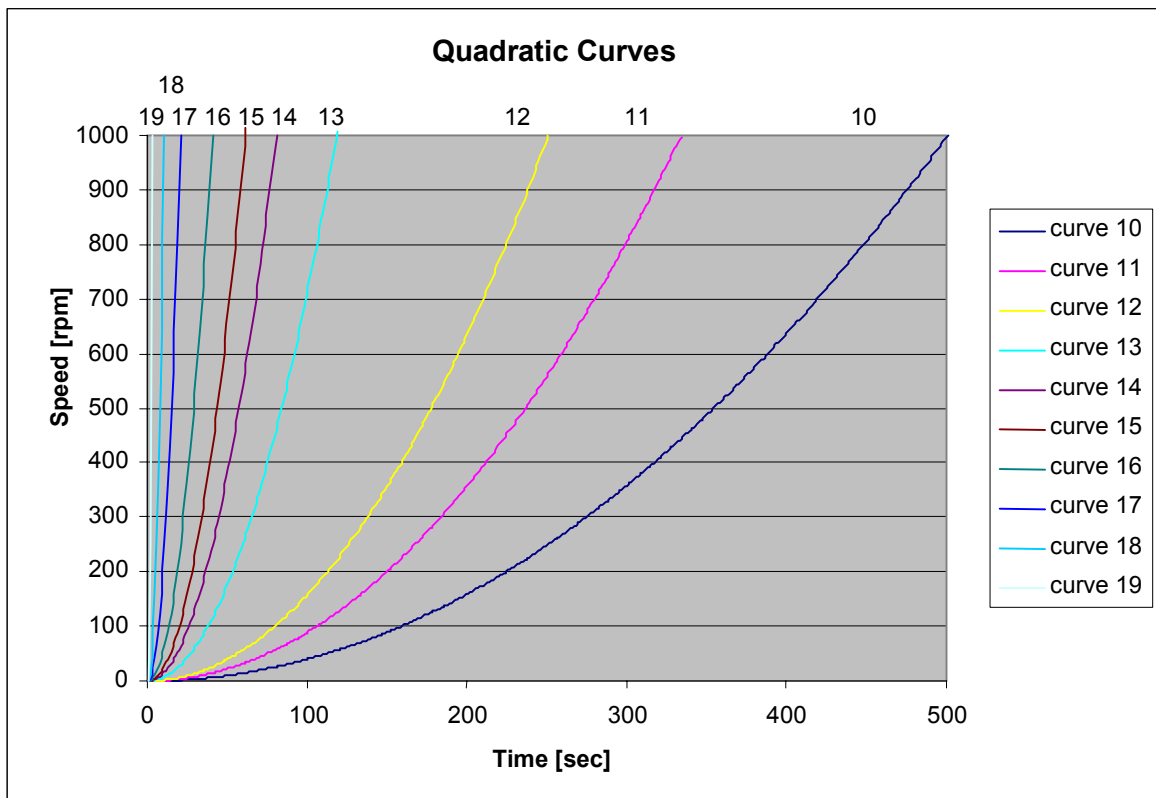

Fig. 40: Diagram of quadratic curves



## 11.4 Table of the service life of rotors and accessories

If no other data concerning the service life are engraved on the rotor or accessory, rotors and buckets must be checked by the manufacturer after 10,000 cycles. After 50,000 cycles, rotors must be scrapped for safety reasons.

Rotor / bucket	Cycles	Service life ("Exp.Date")	Autoclaving	Suitable for centrifuge	Remarks
11026		7 years		1-14, 1-14K	
12082		7 years		1-14, 1-14K	
12083		7 years		1-14, 1-14K	
12084		7 years		1-14, 1-14K	
12085		7 years		1-14, 1-14K	
12092		5 years	20x	1-14, 1-14K	
12093		5 years	20x	1-14, 1-14K	
12094		5 years	20x	1-14, 1-14K	
12096		5 years	20x	1-14, 1-14K	
12101		5 years	20x	1-15, 1-15K, 1-15P, 1-15PK	
12124		5 years	20x	1-15, 1-15K, 1-15P, 1-15PK	
12126		5 years	20x	1-15, 1-15K, 1-15P, 1-15PK	
12134		5 years	20x	1-16, 1-16K	
12135		5 years	20x	1-16, 1-16K	
12137		5 years	20x	1-16, 1-16K	
9100	15,000			4-15C, 4K15C, 4-16, 4-16S, 4-16K, 4-16KS, 6-15, 6K15, 6-16, 6-16K	without engraving, only "spincontrol professional" and "spincontrol S"
12500		7 years		6-15, 6K15, 6-16, 6-16K	
12600		7 years		6-16S, 6-16KS	
13218	20,000			4-16, 4-16S, 4-16K, 4-16KS, 6-16, 6-16S, 6-16K, 6-16KS	
13635	25,000			6-16, 6-16K, 6-16S, 6-16KS	
13845	20,000			8K, 8KS	
13850	10,000			8K, 8KS, 8KBS	
13860	35,000			8K, 8KS, 8KBS	
13864	1,000			8K, 8KS	without engraving
13865	1,000			8K, 8KS	without engraving
13866	1,000			8K, 8KS	without engraving

## 11 Appendix

### 11.5 Resistance data



**NOTE**

The data refer to resistance at 20°C.

Medium	Formula	Concentration [%]	High Density Polyethylene	Polyamide	Polycarbonate	Polyoxymethylene	Polypropylene	Polysulfone	Polyvinyl chloride, hard	Polyvinyl chloride, weak	Polytetrafluorethylene	Acrylonitrile-butadiene- caoutchouc	Aluminium
			HDPE	PA	PC	POM	PP	PSU	PVC	PVC	PTFE	NBR	AL
- no data 1 resistant 2 practically resistant 3 partially resistant 4 not resistant													
Acetaldehyde	C <sub>2</sub> H <sub>4</sub> O	40	3	2	4	2	3	4	4	-	1	4	1
Acetamide	C <sub>2</sub> H <sub>5</sub> NO	saturated	1	1	4	1	1	4	4	-	1	-	1
Acetone	C <sub>3</sub> H <sub>6</sub> O	100	1	1	4	1	1	4	4	-	1	4	1
Acrylonitrile	C <sub>3</sub> H <sub>3</sub> N	100	1	1	4	3	3	4	4	4	1	4	1
Allyl alcohol	C <sub>3</sub> H <sub>6</sub> O	96	1	3	3	2	2	2	2	4	1	1	1
Aluminium chloride	AlCl <sub>3</sub>	saturated	1	3	2	4	1	-	1	-	1	1	4
Aluminium sulfate	Al <sub>2</sub> (SO <sub>4</sub> ) <sub>3</sub>	10	1	1	1	3	1	1	1	1	1	1	1
Ammonium chloride	(NH <sub>4</sub> )Cl	aqueous	1	1	1	2	1	1	1	1	1	1	3
Ammonium hydroxide	NH <sub>3</sub> + H <sub>2</sub> O	30	1	3	4	1	1	2	1	-	1	-	1
Aniline	C <sub>6</sub> H <sub>7</sub> N	100	1	3	4	1	2	4	4	4	1	4	1
Anisole	C <sub>7</sub> H <sub>8</sub> O	100	3	4	4	1	4	4	2	-	1	4	1
Antimony trichloride	SbCl <sub>3</sub>	90	1	4	1	4	1	-	1	-	1	-	4
Benzaldehyde	C <sub>7</sub> H <sub>6</sub> O	100	1	3	4	1	1	3	4	4	1	4	1
Benzene	C <sub>6</sub> H <sub>6</sub>	100	3	2	4	1	3	4	4	-	1	4	1
Boric acid	H <sub>3</sub> BO <sub>3</sub>	aqueous	1	3	1	2	1	-	-	-	1	1	1
Butyl acrylate	C <sub>7</sub> H <sub>12</sub> O <sub>2</sub>	100	1	2	4	2	3	4	4	4	1	-	1
Butyl alcohol, normal	C <sub>4</sub> H <sub>10</sub> O	100	1	1	2	1	1	2	2	4	1	1	1
Calcium chloride	CaCl <sub>2</sub>	alcoholic	1	4	2	3	1	-	-	4	1	1	3
Carbon disulfide	CS <sub>2</sub>	100	4	3	4	2	4	4	4	4	1	3	1
Carbon tetrachloride (TETRA)	CCl <sub>4</sub>	100	4	4	4	2	4	4	4	4	1	3	1
Chlorine	Cl <sub>2</sub>	100	4	4	4	4	4	4	4	4	1	-	3
Chlorine water	Cl <sub>2</sub> x H <sub>2</sub> O		3	4	4	4	3	-	3	3	1	-	4
Chlorobenzene	C <sub>6</sub> H <sub>5</sub> Cl	100	3	4	4	1	3	4	4	4	1	4	1
Chloroform	CHCl <sub>3</sub>	100	3	3	4	4	3	4	4	4	1	4	3

- no data 1 resistant 2 practically resistant 3 partially resistant 4 not resistant		Concentration	High Density Polyethylene	Polyamide	Polycarbonate	Polyoxymethylene	Polypropylene	Polysulfone	Polyvinyl chloride, hard	Polyvinyl chloride, weak	Polytetrafluorethylene	Acrylonitrile-butadiene-caoutchouc	Aluminium	
			Medium	Formula	[%]	HDPE	PA	PC	POM	PP	PSU	PVC	PVC	PTFE
	Chromic acid	CrO <sub>3</sub>	10	1	4	2	4	1	4	1	-	1	4	1
	Chromic potassium sulphate	KCr(SO <sub>4</sub> ) <sub>2</sub> x 12H <sub>2</sub> O	saturated	1	2	1	3	1	-	1	-	1	-	3
	Citric acid	C <sub>6</sub> H <sub>8</sub> O <sub>7</sub>	10	1	1	1	2	1	1	1	1	1	1	1
	Citric acid	C <sub>6</sub> H <sub>8</sub> O <sub>7</sub>	50	1	3	1	2	1	-	-	-	1	1	1
	Copper sulphate	CuSO <sub>4</sub> x 5H <sub>2</sub> O	10	1	1	1	1	1	1	1	1	1	1	4
	Cyclohexanol	C <sub>6</sub> H <sub>12</sub> O	100	1	1	3	1	1	1	1	4	1	2	1
	Decane	C <sub>10</sub> H <sub>22</sub>	100	-	1	2	1	3	-	-	-	1	2	1
	Diaminoethane	C <sub>2</sub> H <sub>8</sub> N <sub>2</sub>	100	1	1	3	1	1	-	3	4	1	1	1
	Diesel fuel	—	100	1	1	3	1	1	-	1	3	1	1	1
	Dimethyl formamide (DMF)	C <sub>3</sub> D <sub>7</sub> NO	100	1	1	4	1	1	4	3	-	1	3	1
	Dimethyl sulfoxide (DMSO)	C <sub>2</sub> H <sub>6</sub> SO	100	1	2	4	1	1	4	4	-	1	-	1
	Dimethylaniline	C <sub>8</sub> H <sub>11</sub> N	100	-	3	4	2	4	-	-	-	1	-	1
	Dioxane	C <sub>4</sub> H <sub>8</sub> O <sub>2</sub>	100	2	1	4	1	3	2	3	4	1	3	1
	Dipropylene glycol (mono)methyl ether	C <sub>4</sub> H <sub>10</sub> O	100	3	1	4	1	4	4	4	4	1	-	1
	Ethyl acetate	C <sub>4</sub> H <sub>8</sub> O <sub>2</sub>	100	1	1	4	1	1	4	4	4	1	4	1
	Ethylene chloride	C <sub>2</sub> H <sub>4</sub> Cl <sub>2</sub>	100	3	3	4	1	3	4	4	4	1	-	1
	Ferrous chloride	FeCl <sub>2</sub>	saturated	1	3	1	3	1	1	1	1	1	-	4
	Formaldehyde solution	CH <sub>2</sub> O	30	1	3	1	1	1	-	-	-	1	2	1
	Formic acid	CH <sub>2</sub> O <sub>2</sub>	100	1	4	3	4	1	3	3	1	1	2	1
	Furfural	C <sub>5</sub> H <sub>4</sub> O <sub>2</sub>	100	1	3	3	2	4	-	-	-	1	4	1
	Gasoline	C <sub>5</sub> H <sub>12</sub> - C <sub>12</sub> H <sub>26</sub>	100	2	1	3	1	3	3	2	-	1	1	1
	Glycerol	C <sub>3</sub> H <sub>8</sub> O <sub>3</sub>	100	1	1	3	1	1	1	1	2	1	1	1
	Heptane, normal	C <sub>7</sub> H <sub>16</sub>	100	2	1	1	1	2	1	2	4	1	1	1
	Hexane, n-	C <sub>6</sub> H <sub>14</sub>	100	2	1	2	1	2	1	2	4	1	1	1
	Hydrogen chloride	HCl	5	1	4	1	4	1	1	1	-	1	2	4
	Hydrogen chloride	HCl	concentrated	1	4	4	4	1	1	2	3	1	4	4
	Hydrogen peroxide	H <sub>2</sub> O <sub>2</sub>	3	1	3	1	1	1	1	1	-	1	3	3
	Hydrogen peroxide	H <sub>2</sub> O <sub>2</sub>	30	1	4	1	4	1	1	1	-	1	3	3
	Hydrogen sulphide	H <sub>2</sub> S	10	1	1	1	1	1	1	1	3	1	3	1

11 Appendix

- no data 1 resistant 2 practically resistant 3 partially resistant 4 not resistant	Concentration	High Density Polyethylene	Polyamide	Polycarbonate	Polyoxymethylene	Polypropylene	Polysulfone	Polyvinyl chloride, hard	Polyvinyl chloride, weak	Polytetrafluorethylene	Acrylonitrile-butadiene-caoutchouc	Aluminium	
													Medium
Iodine, tincture of	I <sub>2</sub>		1	4	3	1	1	-	4	4	1	1	1
Isopropyl alcohol	C <sub>3</sub> H <sub>8</sub> O	100	1	1	1	1	1	1	1	4	1	-	2
Lactic acid	C <sub>3</sub> H <sub>6</sub> O <sub>3</sub>	3	1	3	1	2	1	1	2	-	1	1	1
Magnesium chloride	MgCl <sub>2</sub>	10	1	1	1	1	1	1	1	1	1	1	1
Mercuric chloride	HgCl <sub>2</sub>	10	1	4	1	3	1	1	1	1	1	1	4
Mercury	Hg	100	1	1	1	1	1	1	1	3	1	1	3
Methyl acetate	C <sub>3</sub> H <sub>6</sub> O <sub>2</sub>	100	1	1	4	2	1	-	4	4	1	-	1
Methyl alcohol	CH <sub>4</sub> O	100	1	2	4	1	1	3	1	3	1	2	1
Methyl benzene	C <sub>7</sub> H <sub>8</sub>	100	3	1	4	1	3	4	4	4	1	4	1
Methyl ethyl ketone (MEK)	C <sub>4</sub> H <sub>8</sub> O	100	1	1	4	1	1	4	4	4	1	4	1
Methylene chloride	CH <sub>2</sub> Cl <sub>2</sub>	100	4	3	4	3	3	4	4	4	1	-	1
Mineral oil	—	100	1	1	1	1	1	1	1	-	1	1	1
Nitric acid	HNO <sub>3</sub>	10	1	4	1	4	1	1	1	-	1	4	3
Nitric acid	HNO <sub>3</sub>	100	4	4	4	4	4	-	4	-	1	4	1
Nitrobenzene	C <sub>6</sub> H <sub>5</sub> NO <sub>2</sub>	100	3	4	4	3	2	4	4	4	1	4	1
Oleic acid	C <sub>18</sub> H <sub>34</sub> O <sub>2</sub>	100	1	1	1	2	1	-	1	-	1	3	1
Oxalic acid	C <sub>2</sub> H <sub>2</sub> O <sub>4</sub> x 2H <sub>2</sub> O	100	1	3	1	4	1	1	1	1	1	2	1
Ozone	O <sub>3</sub>	100	3	4	1	4	3	1	1	-	1	4	2
Petroleum	—	100	1	1	3	1	1	1	1	3	1	1	1
Phenol	C <sub>6</sub> H <sub>6</sub> O	10	1	4	4	4	1	4	1	3	1	3	1
Phenol	C <sub>6</sub> H <sub>6</sub> O	100	2	4	4	4	1	3	4	3	1	3	1
Phosphoric acid	H <sub>3</sub> PO <sub>4</sub>	20	1	4	2	4	1	-	-	-	1	2	4
Phosphorus pentachloride	PCl <sub>5</sub>	100	-	4	4	4	1	-	4	4	1	-	1
Potassium hydrogen carbonate	CHKO <sub>3</sub>	saturated	1	1	2	1	1	-	-	-	1	-	4
Potassium hydroxide	KOH	30	1	1	4	3	1	1	1	1	1	-	4
Potassium hydroxide	KOH	50	1	1	4	3	1	1	1	1	1	-	4
Potassium nitrate	KNO <sub>3</sub>	10	1	1	1	1	1	-	-	-	1	1	1
Potassium permanganate	KMnO <sub>4</sub>	100	1	4	1	1	1	-	1	-	1	3	1
Pyridine	C <sub>5</sub> H <sub>5</sub> N	100	1	1	4	1	3	4	4	4	1	4	1



Medium	Formula	Concentration [%]	Concentration										
			High Density Polyethylene	Polyamide	Polycarbonate	Polyoxymethylene	Polypropylene	Polysulfone	Polyvinyl chloride, hard	Polyvinyl chloride, weak	Polytetrafluorethylene	Acrylonitrile-butadiene-caoutchouc	Aluminium
			HDPE	PA	PC	POM	PP	PSU	PVC	PVC	PTFE	NBR	AL
- no data													
1 resistant													
2 practically resistant													
3 partially resistant													
4 not resistant													
Resorcinol	C <sub>6</sub> H <sub>6</sub> O <sub>2</sub>	5	1	4	2	3	1	4	2	-	1	-	2
Silver nitrate	AgNO <sub>3</sub>	100	1	1	1	1	1	1	1	1	1	2	4
Sodium bisulphite	NaHSO <sub>3</sub>	10	1	1	2	4	1	-	-	-	1	1	1
Sodium carbonate	Na <sub>2</sub> CO <sub>3</sub>	10	1	1	1	1	1	-	-	-	1	-	3
Sodium chloride	NaCl	30	1	1	1	1	1	1	1	1	1	1	3
Sodium hydroxide	NaOH	30	1	1	4	1	1	1	1	1	1	2	4
Sodium hydroxide	NaOH	50	1	1	4	1	1	1	1	-	1	2	4
Sodium sulfate	Na <sub>2</sub> SO <sub>4</sub>	10	1	1	1	1	1	1	1	1	1	1	1
Spirits	C <sub>2</sub> H <sub>6</sub> O	96	1	1	1	1	1	1	1	3	1	-	1
Styrene	C <sub>8</sub> H <sub>8</sub>	100	4	1	4	1	3	-	4	4	1	4	1
Sulphuric acid	H <sub>2</sub> SO <sub>4</sub>	6	1	4	1	4	1	1	1	-	1	2	3
Sulphuric acid	H <sub>2</sub> SO <sub>4</sub>	fuming	4	4	4	4	4	4	4	4	1	4	3
Tallow	—	100	1	1	1	1	1	-	1	1	1	1	1
Tetrahydrofuran (THF)	C <sub>4</sub> H <sub>8</sub> O	100	3	1	4	1	3	4	4	4	1	3	1
Tetrahydronaphthalene	C <sub>10</sub> H <sub>12</sub>	100	3	1	4	1	4	4	4	4	1	-	1
Thionyl chloride	Cl <sub>2</sub> SO	100	4	4	4	2	4	4	4	4	1	-	3
Tin chloride	SnCl <sub>2</sub>	10	1	4	2	2	1	-	-	-	1	1	4
Transformer oil	—	100	1	1	3	3	1	1	1	-	1	1	1
Trichloroethane	C <sub>2</sub> H <sub>3</sub> Cl <sub>3</sub>	100	3	3	4	2	4	4	4	4	1	4	4
Urea	CH <sub>4</sub> N <sub>2</sub> O	10	1	1	1	1	1	-	-	-	1	1	1
Urine	—	100	1	1	1	1	1	-	1	1	1	-	2
Vinegar	C <sub>2</sub> H <sub>4</sub> O <sub>2</sub>	10	1	4	1	1	1	1	1	1	1	2	1
Vinegar	C <sub>2</sub> H <sub>4</sub> O <sub>2</sub>	90	1	4	4	4	1	3	1	4	1	-	1
Wax	—	100	-	1	1		1	-	-	-	1	-	1
Wines	—	100	1	1	1	2	1	1	1	1	1	-	4
Xylene	C <sub>8</sub> H <sub>10</sub>	100	3	1	4	1	4	4	4	4	1	4	1



## 11.6 EC-Declaration of Conformity



### EC – DECLARATION OF CONFORMITY

The product named hereinafter was developed, designed, and manufactured in compliance with the relevant, fundamental safety and health requirements of the listed EC directives and norms. In the event of modifications that were not authorised by us or if the product is used in a manner that is not in line with the intended purpose, this declaration will be rendered void.

<i>Product name:</i>	Laboratory Centrifuge
<i>Product type:</i>	Sigma 8KS Sigma 8KBS
<i>Order number:</i>	10620, 10621, 10622, 10623 10625, 10626, 91080
<i>Directives:</i>	2006/42/EG Machinery Directive 2006/95/EG Low Voltage Directive 2004/108/EG EMC Directive
<i>Normes:</i>	EN 61010-2-020:2007 EN 61000-3-2:2006, A1:2008, A2 :2009 EN 61000-3-3:2008 EN 61326-1:2006

**Sigma Laborzentrifugen GmbH**

An der Unteren Söse 50  
 37520 Osterode  
 Germany

Authorised Representative for the  
 documentation:  
 Eckhard Tödteberg

Osterode, 08.01.2014

*Michael Sender*  
 General Manager

8KS\_2014-01-08\_en.doc



### 11.7 Layout plan

here: water cooled centrifuge, GMP version, part no. 10623

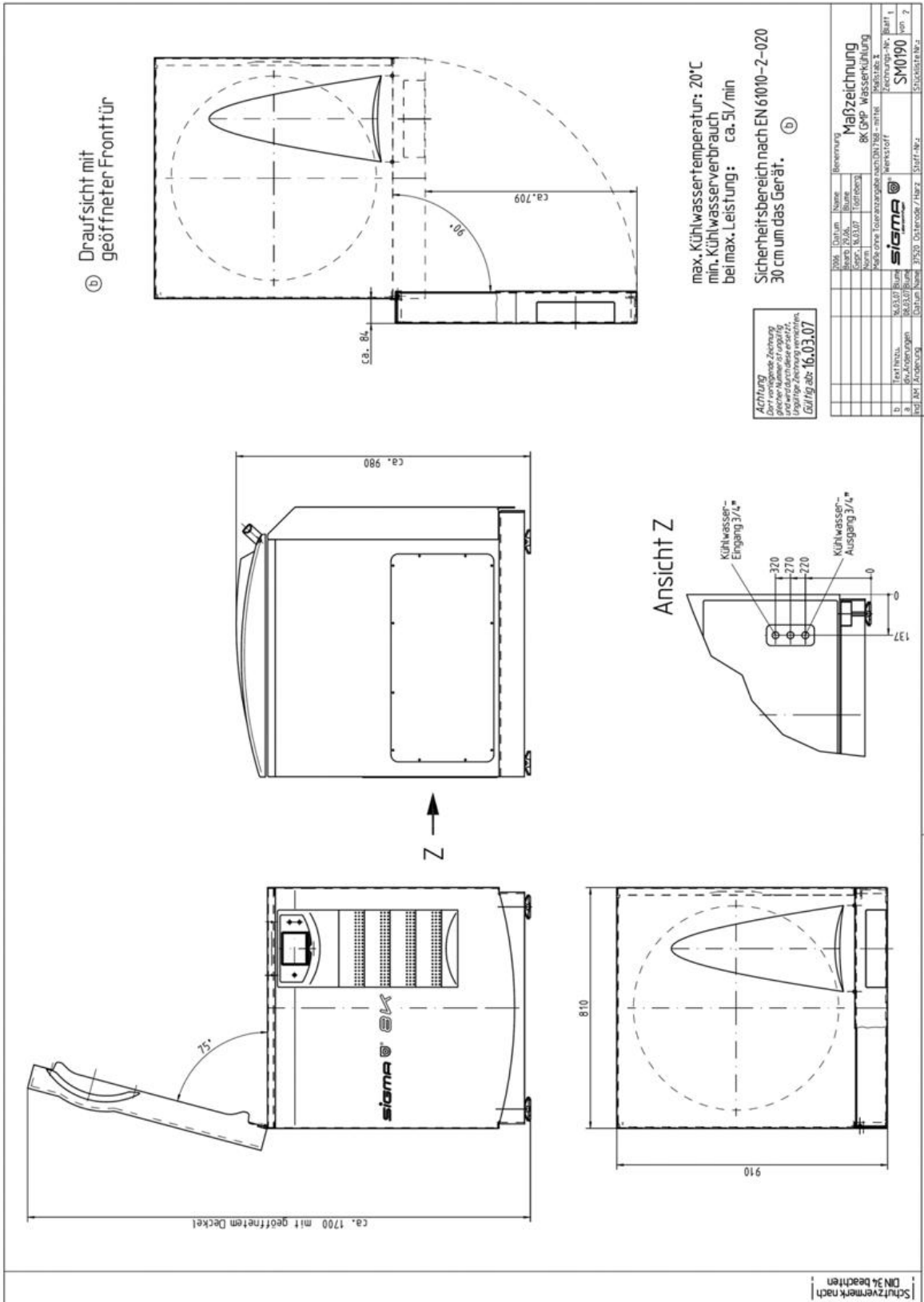



## 12 Index

### A

Acceleration .....	44
Acceleration curve .....	44, 51, 75
Accessories for blood bags .....	71
Accessories, cleaning and care .....	62
Acid .....	21, 61, 63
Acoustic signal .....	50, 57
Activating the help function .....	52
Adapter .....	62
Adapters .....	36
Adapters and stainless steel tubes .....	72
Alignment .....	28
Alignment of the centrifuge .....	27
Alkaline solutions .....	21, 61, 63
Ambient conditions .....	70
Ambient temperature .....	70
Anodised coating .....	62
Application examples .....	14
Autoclaving .....	65
Automatic lid opening function .....	48
Automatic program rotation .....	55
Automatic rotor identification .....	42

### B

Blocking a function .....	47
Blood bag systems .....	37
Brake .....	44
Brief mains power failure .....	57
Bucket .....	36
Buckets, cleaning and care .....	63
Buzzer .....	50

### C

Capacity .....	69
Carrier .....	36
Carrier systems .....	36
Carriers, cleaning and care .....	63
CE mark in compliance with the directive 2006/42/EC .....	16
Centrifugation monitoring .....	46
Centrifugation of blood bag systems .....	37
Centrifugation of infectious, toxic, radioactive, or pathogenic substances .....	20

Centrifugation principle .....	14
Centrifugation with different tube sizes .....	35
Centrifugation with low capacity .....	35
Centrifuge cannot be started .....	57
Centrifuge decelerates during operation .....	57
Centrifuge is inclined .....	57
Centrifuge was moved during run .....	57
Centrifuge, cleaning and care .....	61
Centrifuges	
- definition .....	9
Changes in colour .....	65
Changes in structure .....	65
Changing the code .....	48
Changing the contrast .....	53
Chemical and biological safety .....	20
Chemical resistance of plastic .....	63
Cleaning agents .....	64
Cleaning the bores of angle rotors .....	62
Cleaning the centrifuge .....	61
Closing the lid .....	19, 33
Code .....	47
Communication error .....	59
Condensate .....	30
Condensate drain .....	30
Condensation .....	27
Condenser dirty .....	57
Condenser, cleaning and care .....	62
Connected load .....	69
Connection .....	30
Contamination .....	20, 62
Continuous heat resistance .....	64
Continuous run .....	41
Control system .....	38
Cooling water connection .....	12
Copyright .....	10
Corrosion .....	19, 22, 36, 61, 62, 63, 64
Cracking .....	62
Cracks .....	63
Creating and editing an acceleration curve .....	51
Current consumption .....	69
Curve menu .....	51
Cycles .....	34, 50

12 Index

<b>D</b>	
Damage of the surface.....	63
Dangerous goods.....	21
Dangerous materials.....	64
Deactivating the help function.....	52
Deceleration.....	44
Deceleration curve.....	51, 75
Declaration of Conformity.....	83
Declaration of decontamination.....	67
Declaration of Decontamination.....	68
Decontamination agent.....	62, 64
Deformation of tubes.....	65
Deleting a program.....	55
Density.....	21, 46
Dialog box.....	23
Different service life of rotors and accessories.....	22, 37, 77
Dimensions.....	25
Direct hazard to the life and health.....	17
Directive 2002/96/EC.....	68
Disinfectants.....	64
Disinfection of the rotor chamber and accessories.....	64
Display.....	38, 49
Display deceleration time.....	49
Disposal of the centrifuge.....	68
Disposal of the packaging.....	68
Draining the condensate off.....	30
Drive problem.....	57
<b>E</b>	
Earth conductor check.....	23
EC-Declaration of Conformity.....	83
EEPROM error.....	59
Electrical connection.....	69
Electrical safety.....	19
EMC as per EN 61326.....	69
Equipotential bonding screw.....	23
Error correction.....	57
Error message.....	57
Explanation of the symbols and notes.....	17
Explosive substances.....	20
External.....	50
<b>F</b>	
Fire preventions.....	20
Flow rate.....	32
Form for the return of defective parts.....	67
Function.....	48
Functional and operating elements.....	11
Fuses.....	30
Fuses have tripped.....	57
<b>G</b>	
General conditions.....	9
Glass breakage.....	64
Glass particles.....	64
GMP version.....	32
Gravitational field.....	69
Grease for load bearing bolts.....	61, 63
<b>H</b>	
Hazard warnings.....	9, 36
Heater.....	40
Help menu.....	52
Highly corrosive substances.....	19
<b>I</b>	
Identifying and adapting incorrectly set rotors.....	42
Imbalance.....	35, 36, 37, 63
Imbalance error.....	59
Imbalance monitoring system.....	23
Importance of the operating manual.....	9
Important information.....	17
Improper loading.....	57
Infectious substances.....	64
Inflammable substances.....	20
Informal safety instructions.....	18
Initial start-up.....	33
Input fuse.....	69
Inspection by the manufacturer.....	66
Installation of accessories.....	35
Installation of angle rotors with a hermetically sealed lid.....	34
Installation of rotors and accessories.....	33
Installation of the rotor.....	34
Intended use.....	9
Interrupting a centrifugation run.....	39
Interrupting a deceleration process.....	39
Interval number.....	51
Invert.....	49
IP code.....	69



<b>K</b>	Notes on safety and hazards.....	9
Kinetic energy .....		69
<b>L</b>	<b>O</b>	
Language.....	Online download of forms .....	67
Layout of the centrifuge.....	Open lid after run .....	48
Layout plan .....	Opening the lid.....	33
Leaks.....	Operating conditions for water cooled centrifuges.....	32
Lid cannot be opened .....	Operating personnel .....	18
Lid error .....	Operating voltage.....	30
Lid lock device .....	Operational safety.....	62
Lid lock has not released .....	Optical signal .....	50
Lid locks.....	Options for data input and output.....	50, 56
Lid seal sticks .....	Overheating .....	27
Lifting and carrying rotors.....	Overseas shipping .....	25
Linear curves .....	<b>P</b>	
Load bearing bolts, cleaning and care.....	Packaging.....	26
Lock.....	Parameter error.....	59
<b>M</b>	Parameters menu .....	45
Mains plug .....	Pathogenic substances.....	20, 61, 64
Mains power switch off.....	Plastic accessories, cleaning and care.....	63
Mains voltage.....	Potential hazard due to biological substances .....	17
Maintenance .....	Potential hazard to the life and health .....	17
Malfunctions and error correction.....	Potentially hazardous situation.....	17
Manual mode .....	Power consumption .....	69
Manufacturer.....	Power cord.....	30
Marking of the unit .....	Power cord is not plugged in.....	57
Maximum runtime of a curve.....	Power isolating device .....	30
Maximum speed for tubes.....	Power supply .....	30
Measures in the event of hazards and accidents.....	Pressure marks.....	63
Mechanical safety .....	Prevention of accidents.....	9
Mode of operation .....	Problem description .....	67
Modification mode is active .....	Process.....	45
Motor error .....	Process error .....	59
Motor shaft.....	Program "RAPID_TEMP" .....	43
Motorized lid locks .....	Program list.....	43
Multiple carrier .....	Program rotation .....	48, 55
<b>N</b>	Program selection list.....	43, 53, 54
Name plate .....	Protection class.....	69
No indication on the display .....	<b>Q</b>	
No power in the mains supply .....	Quadratic curves.....	75
Noise level .....	Quick stop.....	39
Non-greased bolts.....		

12 Index

<b>R</b>	
Radioactive substances .....	20, 61
Radius .....	15, 45
Range of accessories .....	71
RAPID_TEMP program.....	43
RCF .....	40, 45
Refrigerant.....	32
Refrigeration unit.....	32
Relative centrifugal force.....	40
Relative centrifugal force (RCF).....	15
Remove glass particles and metal dust from the rotor chamber.....	64
Responsibility of the operator.....	18
Return of centrifuges, spare parts, or accessories .....	67
Return of defective parts .....	67
Risk of electrical shock.....	19
Rocker switch .....	30
Rotor chamber .....	61
Rotor monitoring system .....	23
Rotor radii .....	73
Rotor selection list.....	42
Rotor tie-down screw .....	34, 63
Rotor/bucket combination .....	42
Rotors and accessories with a different service life .....	22, 37, 77
Rotors, cleaning and care .....	63
Runtime .....	41
Runtime as of set speed .....	49
<b>S</b>	
Safety area .....	21
Safety class .....	30
Safety devices .....	23
Safety distance .....	19, 21
Safety instructions.....	9, 36
Safety instructions for centrifugation .....	21
Safety, chemical and biological.....	20
Safety, electrical.....	19
Safety, mechanical.....	19
Safety-conscious work .....	18
Saving a program.....	54
Scope of supply .....	10
Selection, display, and modification of data	39
Serial number .....	60, 66
Service.....	66
Service contact .....	60
Service life .....	61
Service life of rotors and accessories..	22, 37, 77
Service life of the accessories.....	65
Service life of the adapters for blood bags no. 13864, 13865 and 13866.....	37
Service request.....	60, 66, 70
Service work .....	66
Set-up .....	28
Set-up and connection .....	27
Setup menu .....	48
Set-up of the centrifuge.....	27
Short run .....	41
Solvents.....	21, 61, 63
Sound signal .....	23
Spare part enquiries.....	60
Special equipment: water cooling system..	32, 69
Speed .....	15, 40, 69
Speed/RCF fine .....	49
Speed-gravitational-field-diagram .....	74
Speedometer error.....	59
Spin-out from set speed.....	47
Standard menu .....	40
Standards and regulations .....	10
Standstill cooling.....	45
Standstill monitoring system .....	23
Start delay.....	49
Starting a centrifugation run .....	39
Sterilisation of the rotor chamber and accessories .....	64
Storage and transport .....	25
Storage conditions .....	25
Storage locations .....	69
Storage temperature .....	25
Stress-corrosion see corrosion.....	63
Structural changes .....	20
Supply voltage .....	30
Supporting rings.....	73
Swing-out rotor .....	35
Switching the centrifuge off .....	56

Switching the centrifuge on .....	33	Toxic substances .....	20, 61
System.....	50	Transport .....	26
System check .....	23	Tubes.....	36
System error .....	57, 59	Type.....	69
<b>T</b>		Type of the centrifuge .....	60, 66
Table		<b>U</b>	
Rotors and accessories with a different service life .....	37	Unblocking a function.....	48
Table of error codes.....	59	Ungreased load- bearing bolts .....	57
Table of rotors and accessories with a different service life .....	22, 77	Useful volume	
Technical data .....	69	- volume that is stated for the tube ....	36, 73
Technical documentation .....	70	User interface .....	38
Temperature .....	40	Using smaller blood bag systems.....	37
Temperature at the water inlet .....	32	UV radiation .....	27, 61
Temperature error.....	59	<b>V</b>	
Temperature inside the rotor chamber .....	23	Vessels .....	36
Temperature monitoring.....	47	<b>W</b>	
Temperature monitoring system.....	23	Warranty and liability.....	9
Temperature unit.....	49	Water connector.....	32
Temperature value not reached .....	57	Water cooling system.....	32, 69
Thermal stress .....	61	Water operating pressure.....	32
Threshold delta T.....	47	Wear.....	66
Time fine .....	49	Weight .....	25
Time range.....	69	Work on the power supply system .....	19